

CS-5630 / CS-6630 Visualization

Data

Alexander Lex
alex@sci.utah.edu



ANNOY GRAMMAR PEDANTS ON ALL SIDES BY MAKING "DATA" SINGULAR *EXCEPT* WHEN REFERRING TO THE ANDROID.

Design Critique

CodeSwarm

<https://goo.gl/0DVhMT>

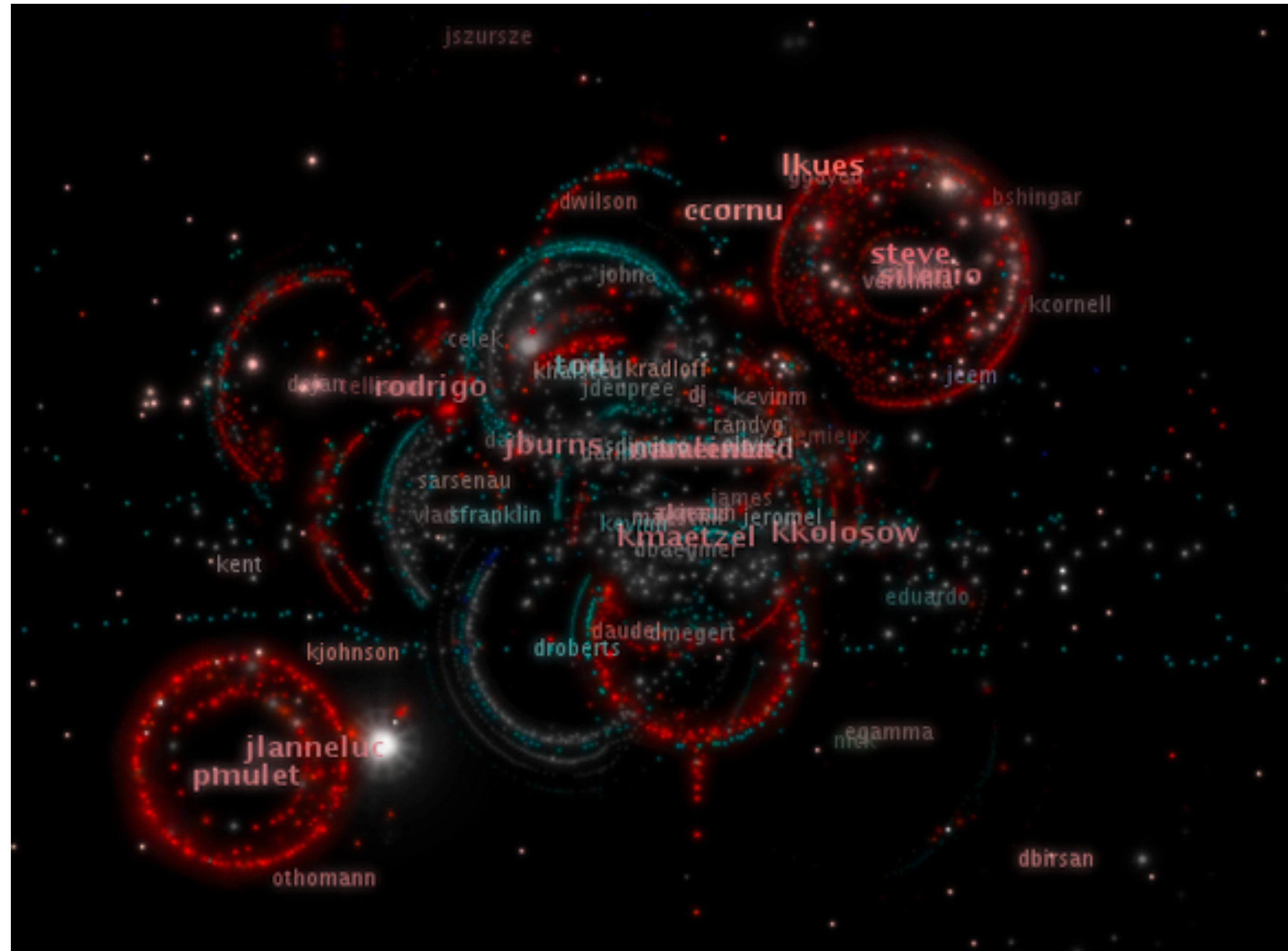

Data

Terms

Dataset Types

what can be visualized?

Data Types

fundamental units

combinations make up Dataset Types

→ Dataset Types

→ Tables

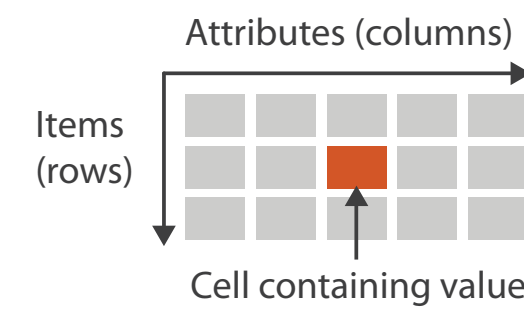

→ Networks

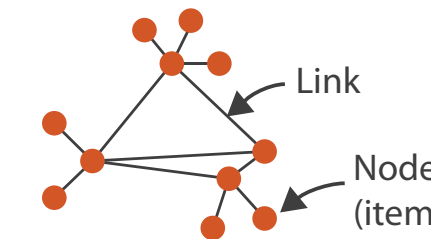

→ Fields (Continuous)

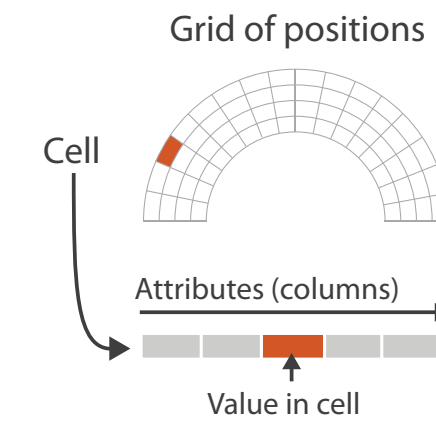

→ Geometry (Spatial)

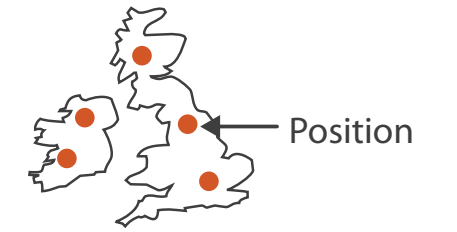

→ Multidimensional Table

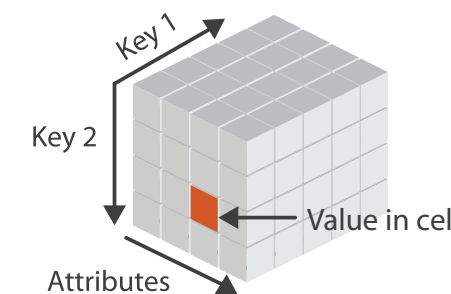

→ Trees

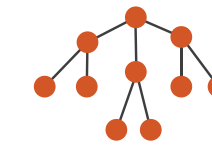

→ Data Types

→ Items

→ Attributes

→ Links

→ Positions

→ Grids

Structure

Structured Data

known data types, semantics

→ Dataset Types

→ Tables

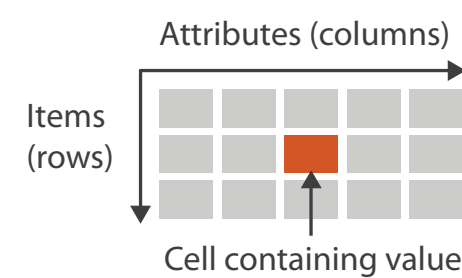

→ Networks

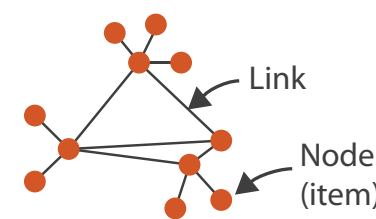

→ Fields (Continuous)

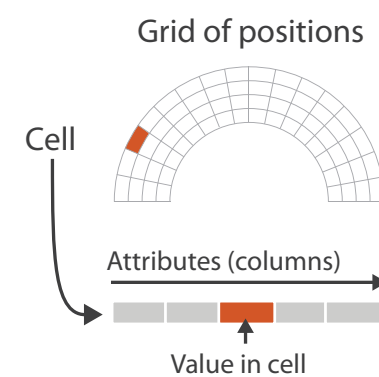

→ Geometry (Spatial)

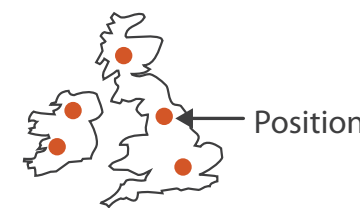

→ Multidimensional Table

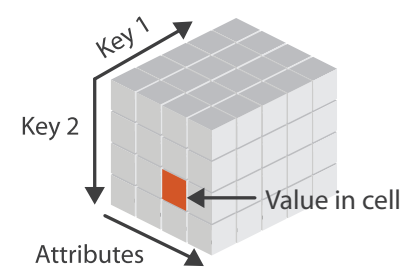

→ Trees

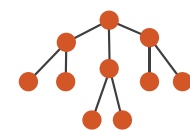

Unstructured Data

no predefined data model

text-heavy, interspersed with facts
(dates, times, locations)

video, images

Translate into structured data

Natural Language Processing

Text mining (sentiment, keywords,
concepts, categories)

Example: Phrase Net

Pattern: “X’s Y”

18th & 19th century
novels

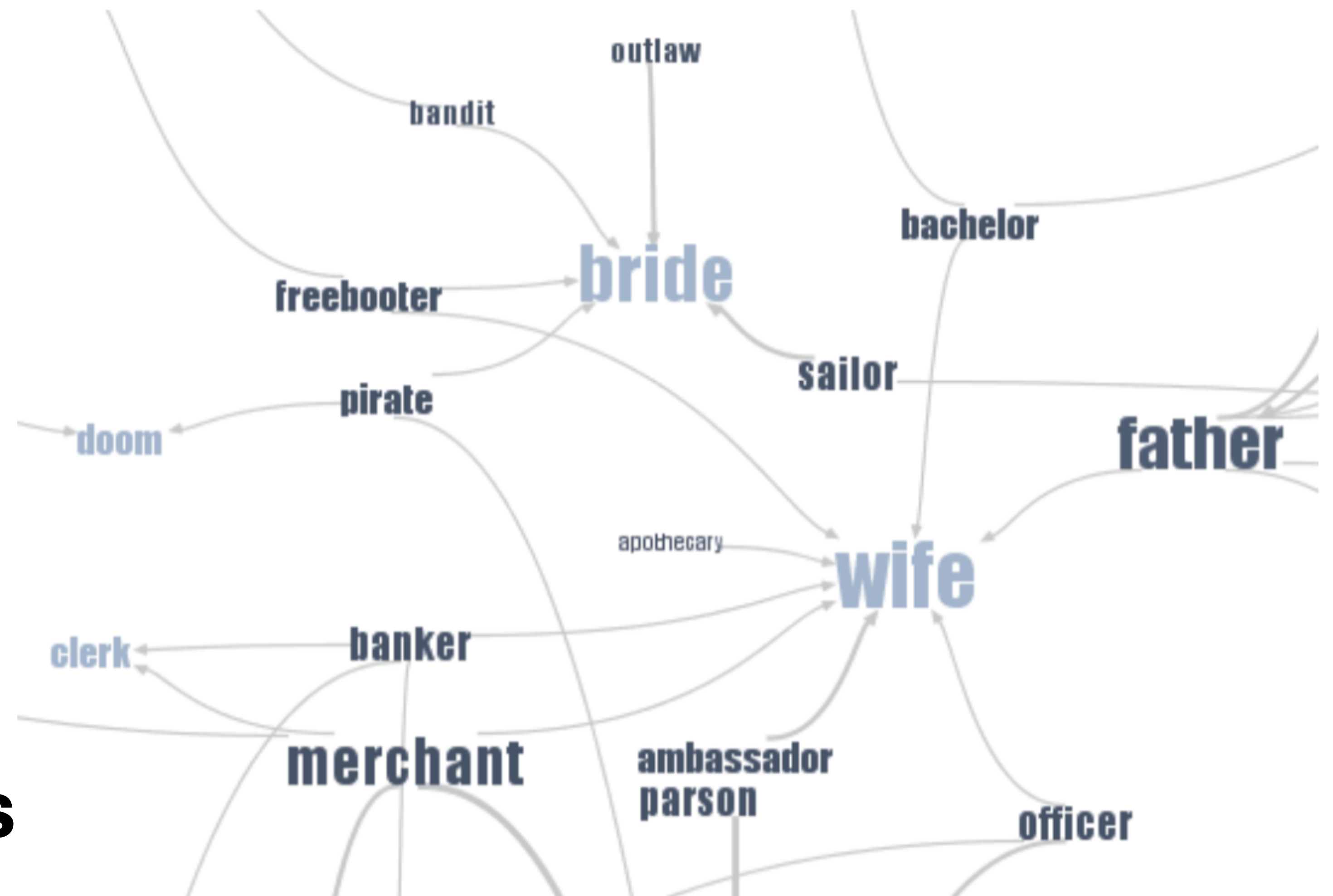

More in Lecture
Text & Document Vis

Data Semantics

ID	Name	Age	Shirt Size	Favorite Fruit
1	Amy	8	S	Apple
2	Basil	7	S	Pear
3	Clara	9	M	Durian
4	Desmond	13	L	Elderberry
5	Ernest	12	L	Peach
6	Fanny	10	S	Lychee
7	George	9	M	Orange
8	Hector	8	L	Loquat
9	Ida	10	M	Pear
10	Amy	12	M	Orange

Basil, 7, S, Pear

What does it mean?

Semantics: real world meaning

Name? City? Fruit? Height? Age? Day of Month?

Metadata

Data Types

structural or mathematical interpretation of data

Item, Link, Attribute, Position, Grid

Different from data types in programming!

Items & Attributes

Item: individual entity, discrete

e.g., Patient, Car, Stock, City

“independent variable”

Attribute: measured, observed,
logged property

e.g., Patient: height, blood pressure

Car: horsepower, make

“dependent variable”

Item: Person Attributes

ID	Name	Age	Shirt Size	Favorite Fruit
1	Amy	8	S	Apple
2	Basil	7	S	Pear
3	Clara	9	M	Durian
4	Desmond	13	L	Elderberry
5	Ernest	12	L	Peach
6	Fanny	10	S	Lychee
7	George	9	M	Orange
8	Hector	8	L	Loquat
9	Ida	10	M	Pear
10	Amy	12	M	Orange

Cell

Other Data Types

Links

Express relationship between two items

Friendship on Facebook, Interaction between proteins

Positions

Spatial data -> location in 2D or 3D

Pixels in photo, Voxels in MRI scan, latitude/longitude

Grids

Sampling strategy for continuous data

How many Voxels in MRI scan, positions of weather stations in the US

Dataset Types

→ Dataset Types

→ Tables

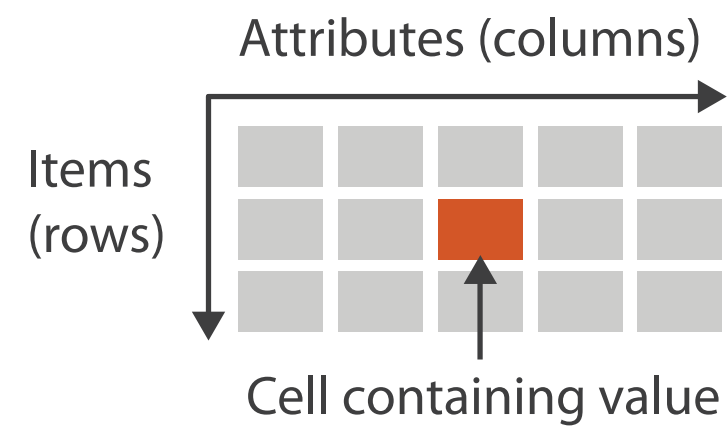

→ Networks

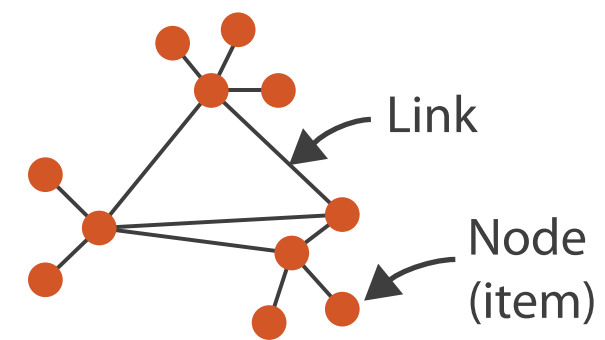

→ Fields (Continuous)

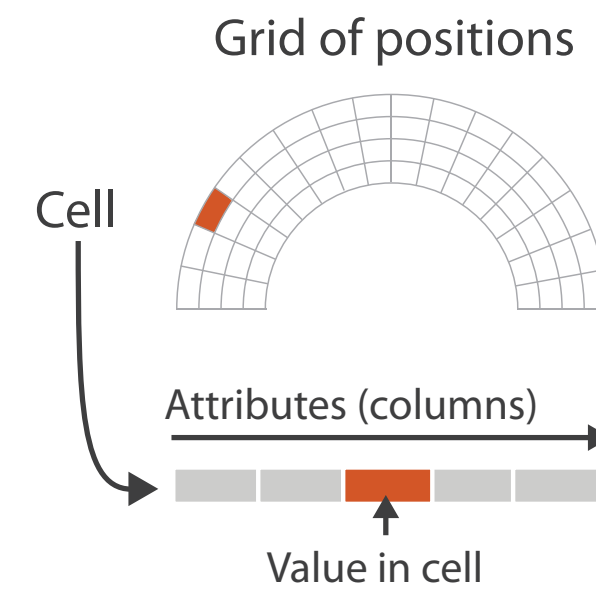

→ Geometry (Spatial)

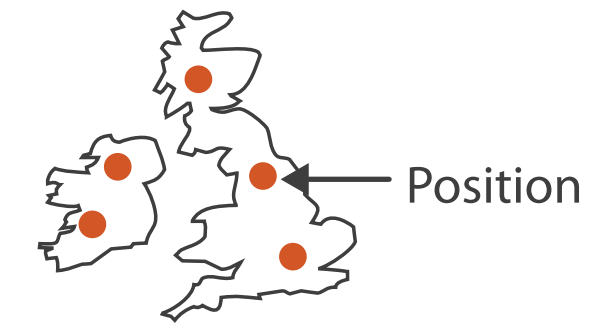

→ Multidimensional Table

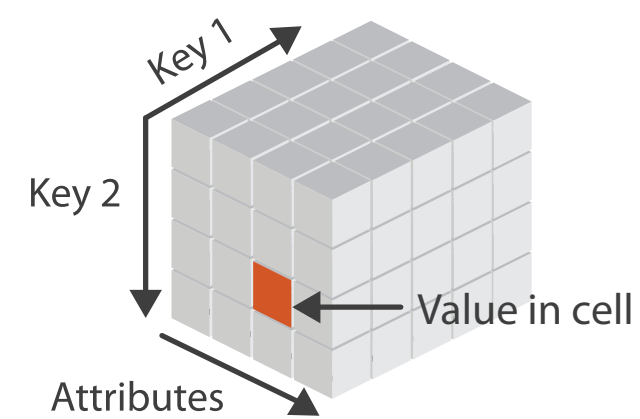

→ Trees

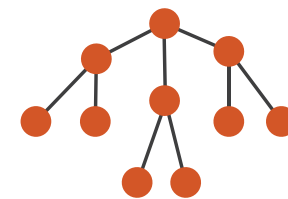

Tables

Flat Table

one item per row

each column is attribute

unique (implicit) **key**

no duplicates

Multidimensional Table

indexing based on multiple keys

	Keys	Attributes			
		Values			
	ID	Name	Age	Shirt Size	Favorite Fruit
	1	Amy	8	S	Apple
	2	Basil	7	S	Pear
Item	3	Clara	9	M	Durian
	4	Desmond	13	L	Elderberry
	5	Ernest	12	L	Peach
	6	Fanny	10	S	Lychee
	7	George	9	M	Orange
	8	Hector	8	L	Loquat
	9	Ida	10	M	Pear
	10	Amy	12	M	Orange

Multidimensional Tables

	A	B	C	D	E
1	#1.2				
2	1500	529			
3	GeneName	DESCRIPTION	TCGA-02-0001-01C-01R-0177-01	TCGA-02-0003-01A-01R-0177-01	TCGA-02-0004-01A-01R-0298-01
4	LTF	LTF	-1.265728057	2.377012066	4.123979585
5	POSTN	POSTN	2.662411805	3.932400324	5.031585377
6	TMSL8	TMSL8	-3.082217838	-2.243148513	-0.02313681
7	HLA-DQA1	HLA-DQA1	-1.739664398	4.577962344	3.127744964
8	RP11-35N6.1	RP11-35N6.1	-3.346352968	-2.895400157	-3.473035067
9	STMN2	STMN2	-2.578511106	-3.051605144	-1.729892888
10	DCX	DCX	-2.26078976	-2.529795801	-2.844966278
11	AGXT2L1	AGXT2L1	-2.639493611	-3.113204863	-0.403975027
12	IL13RA2	IL13RA2	-2.93596915	-1.873600916	2.976256911
13	SLN	SLN	-2.466718221	-2.208406749	1.025827904
14	MEOX2	MEOX2	-2.395054066	-1.062676046	1.783235317
15	COL11A1	COL11A1	1.211934832	-0.399392588	4.733608974
16	NNMT	NNMT	0.703745164	0.664082419	3.069030715
17	F13A1	F13A1	-0.224094042	2.222197544	1.171354775
18	CXCL14	CXCL14	-3.1309694	-1.395056071	2.569540659
19	MBP	MBP	-1.906390566	-2.037626447	-2.935744906
20	TF	TF	-4.334123292	-4.680680246	-2.975788866
21	KCND2	KCND2	-1.777692395	-2.100362021	-1.996306032
22	GABRB1	GABRB1	-2.214760175	-3.022654105	-3.185499425

Keys: Genes

Keys: Patients

Graphs/Networks

A graph $G(V,E)$ consists of a set of **vertices (nodes) V** and a set of **edges (links) E** connecting these vertices.



Diagrammatic Example

Graphs/Networks

A simple graph is a graph which contains

No multi-edges

No loops



Not a simple graph!
→ A *general graph*

Special Graphs

A *tree* is a graph with *no cycles*

A *directed graph* (digraph) is a graph that distinguishes between edges $A \rightarrow B$ and $A \leftarrow B$

A *hypergraph* is a graph with edges connecting any number of vertices

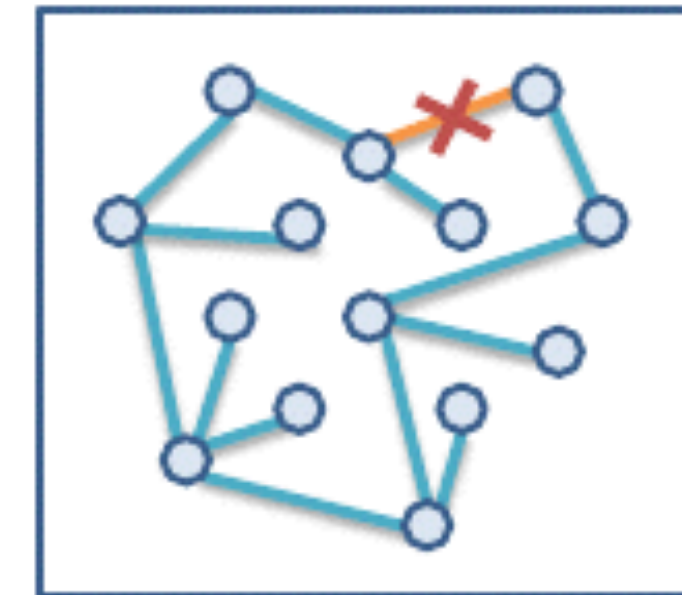

Tree

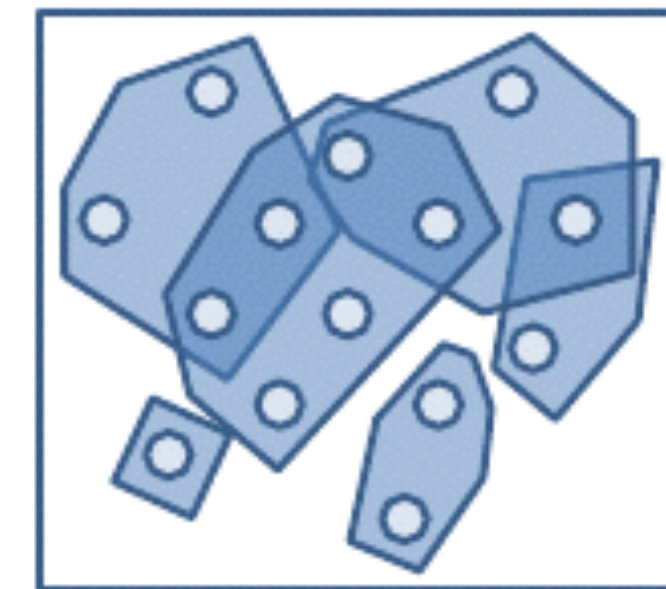

Hypergraph Example

Special Graphs

A *bipartite graph* has vertices that can be partitioned into two independent sets

An *articulation point* is a Vertex, which if deleted from the graph would break up a *connected graph* into multiple graphs, or an *unconnected graph*

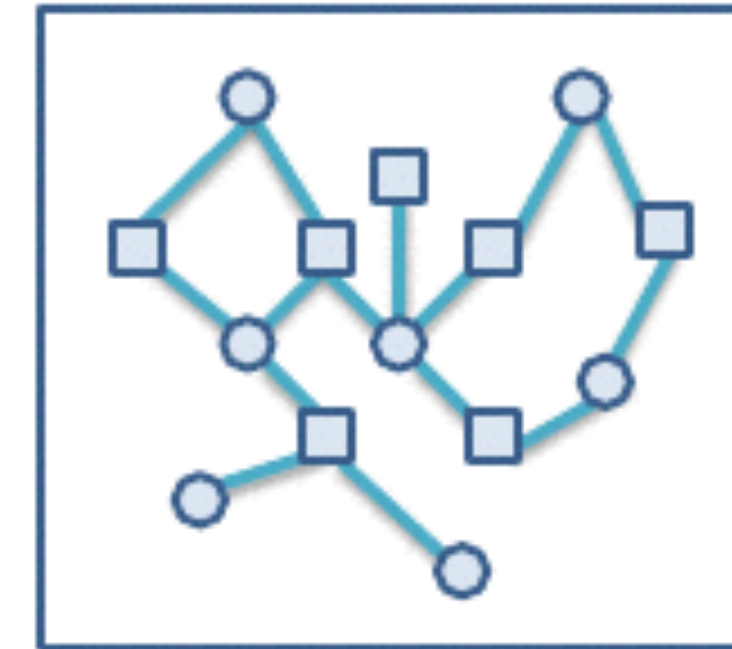

Bipartite Graph

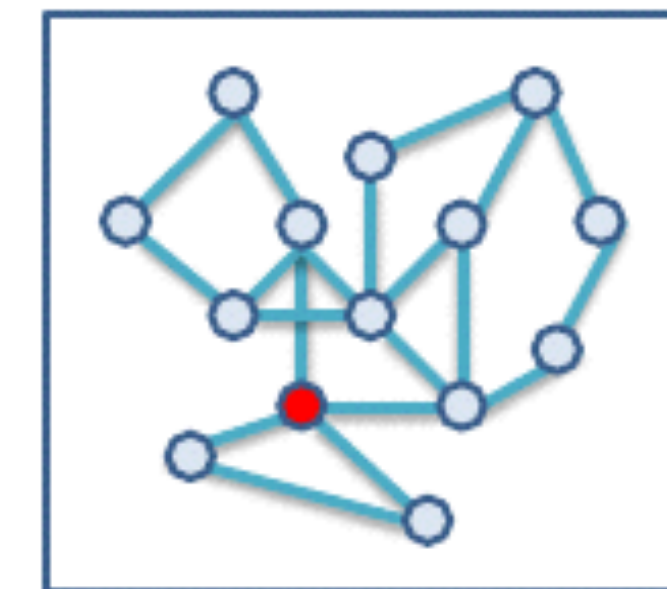

Articulation Point (red)

Visualizing Graphs



Node-Link Diagram

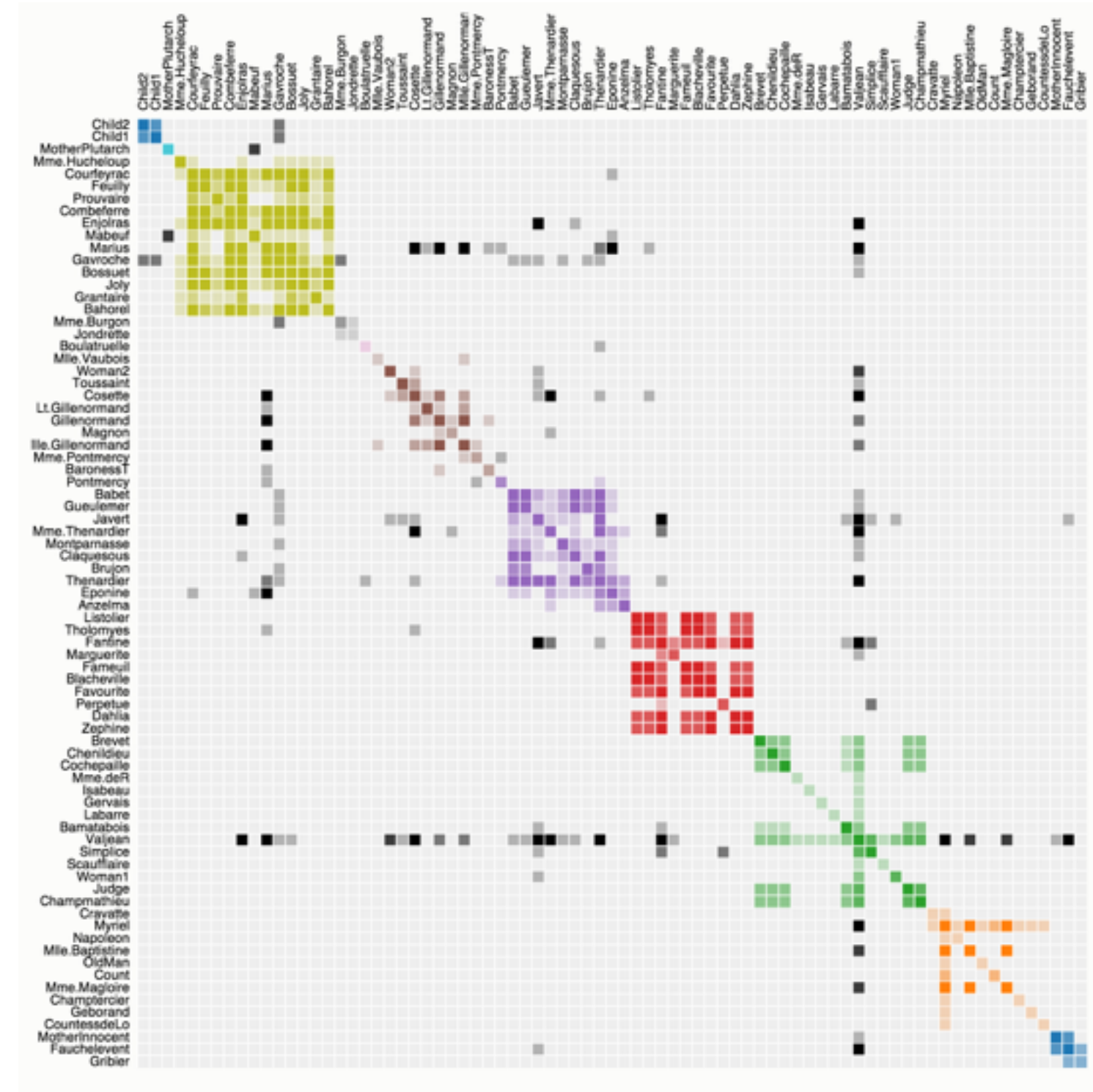

Matrix

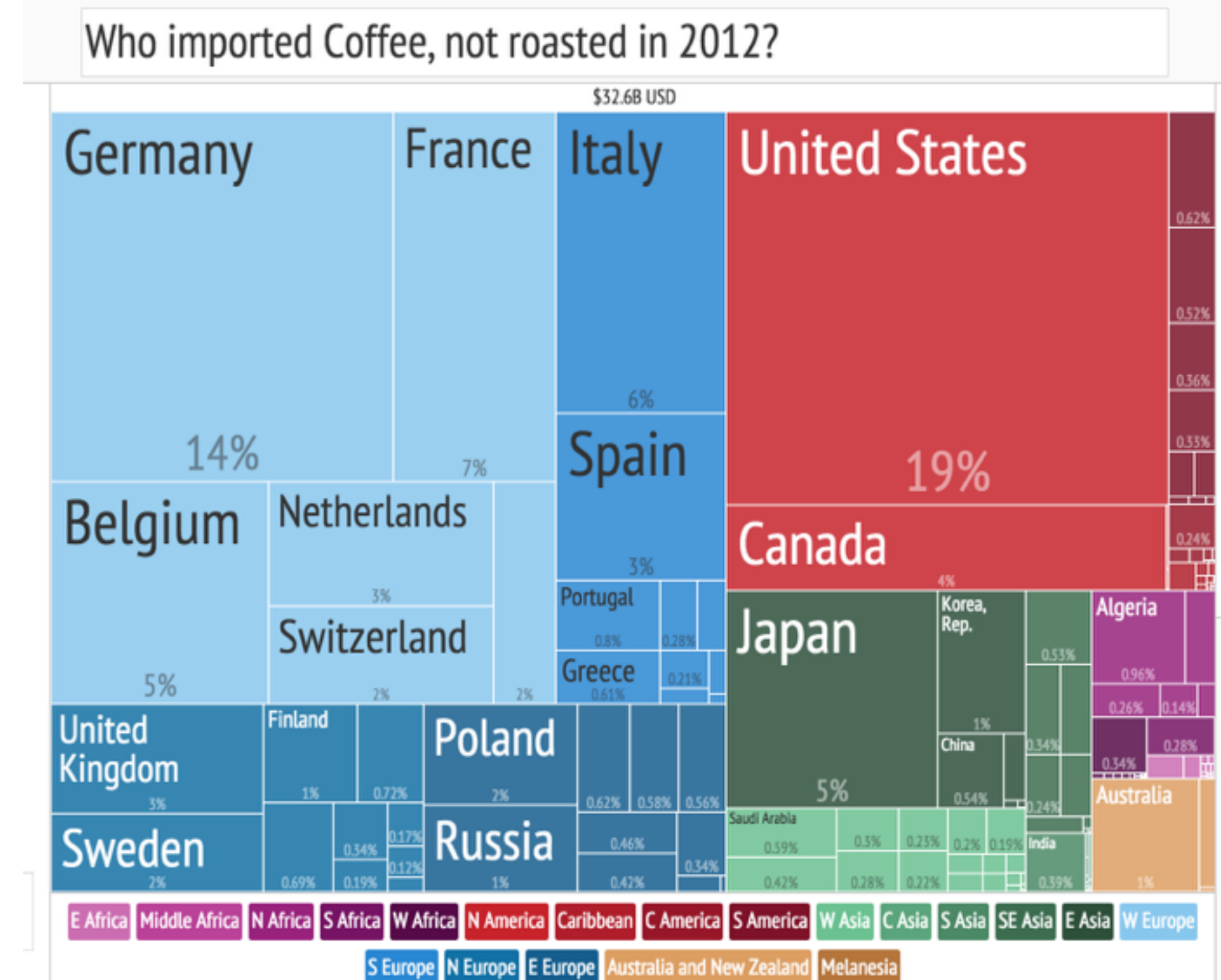

Treemap (Implicit Tree Visualization)

More in Lecture on Graphs & Trees

Fields

Attribute values associated with cells

Cell contains data from continuous domain

Temperature, pressure, wind velocity

Measured or simulated

Sampling & Interpolation

Signal processing & stats

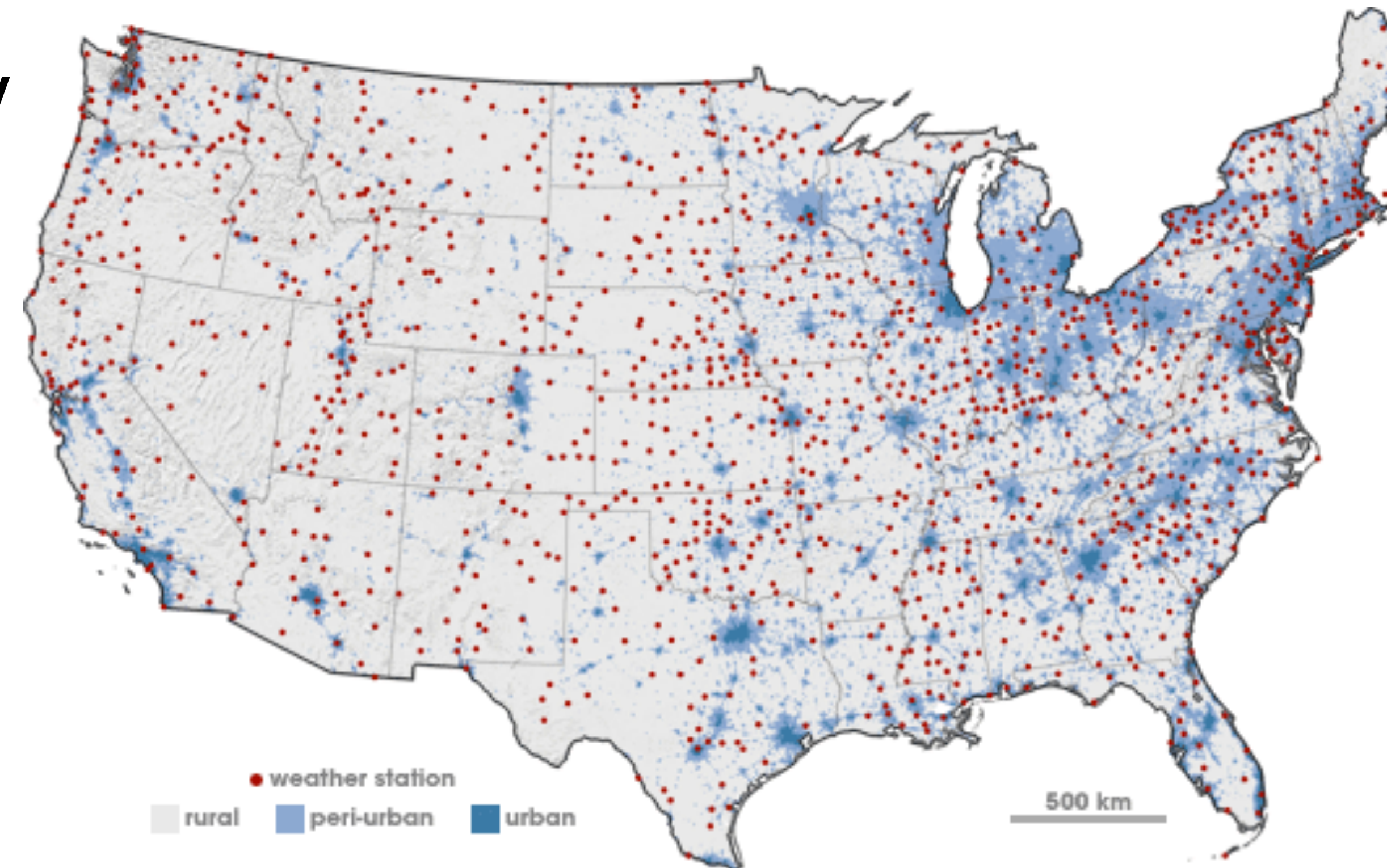

Fields: Grid Types

Uniform Grid

Geometry & topology can be computed

Rectilinear Grid

Nonuniform sampling

Structured Grid

allows curvilinear grids

Unstructured Grid

full flexibility, store position and connection

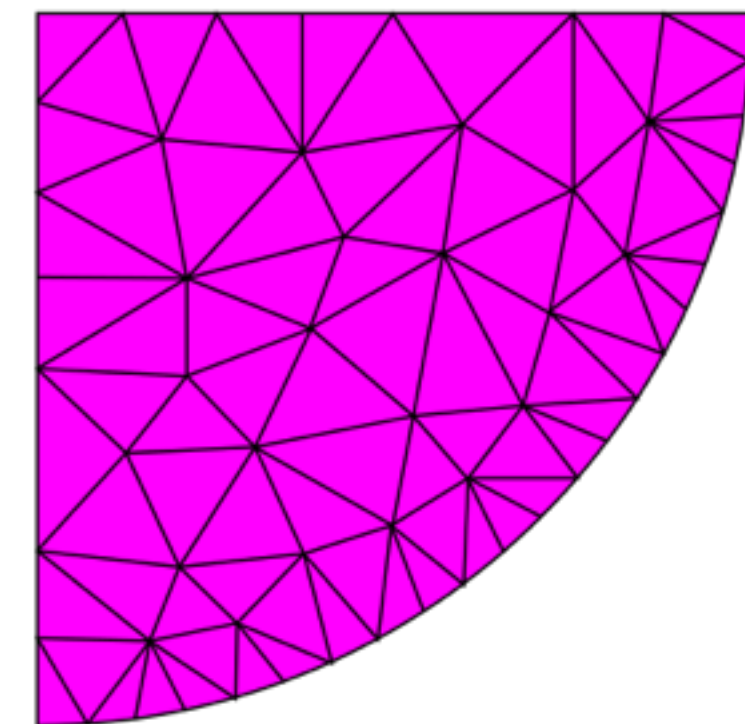
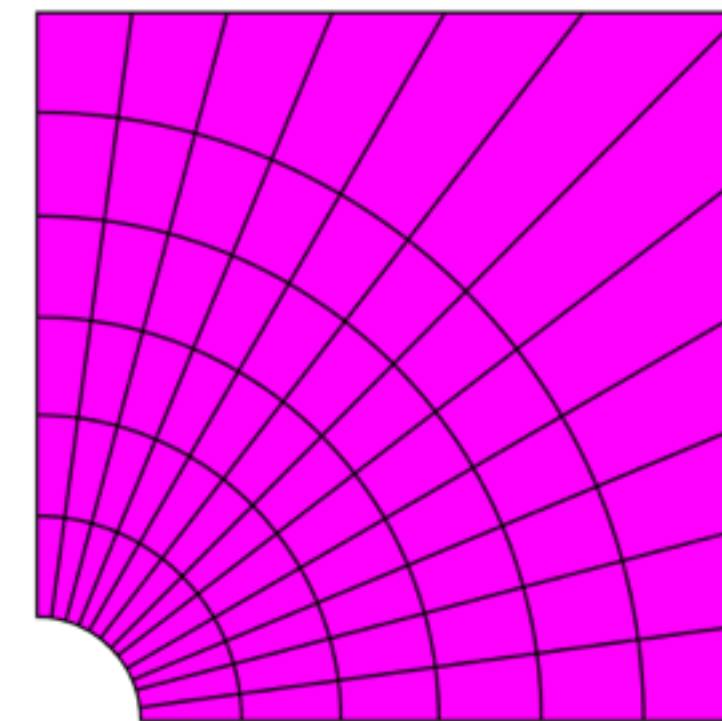
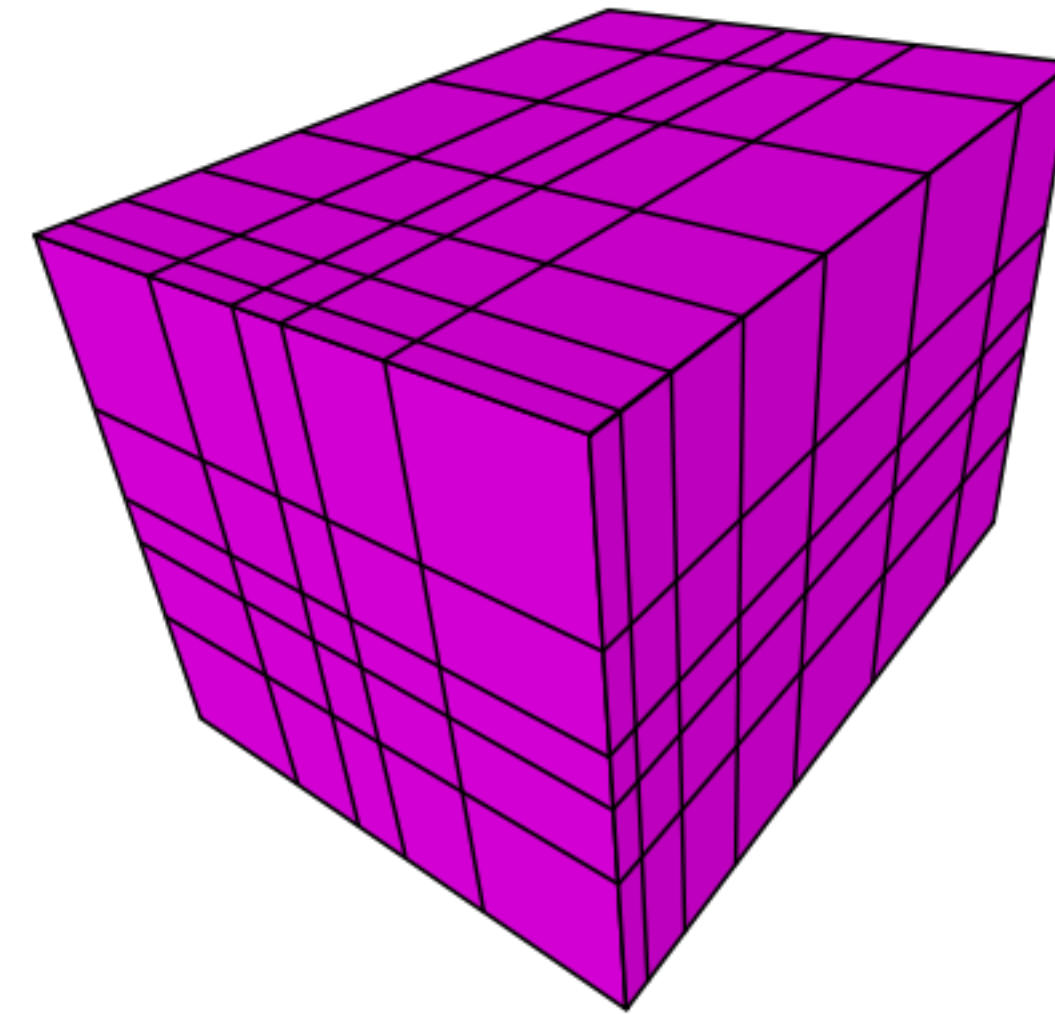
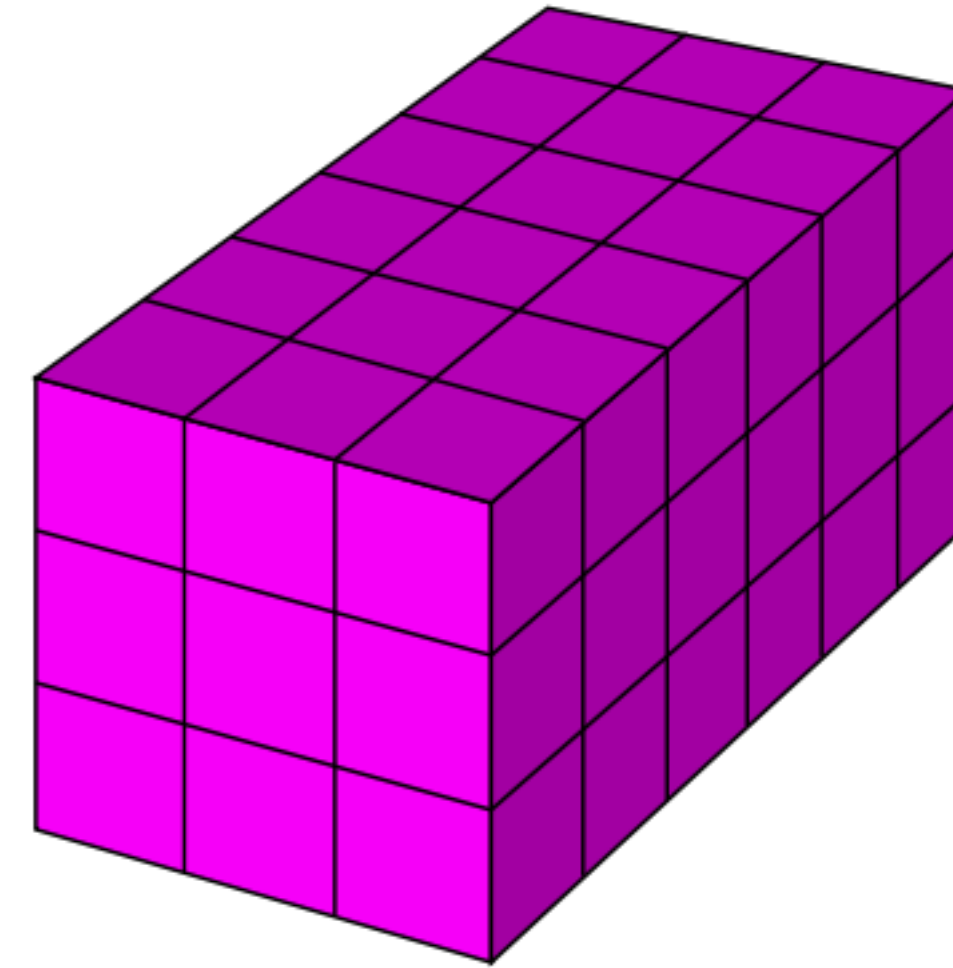

Visualizing Fields

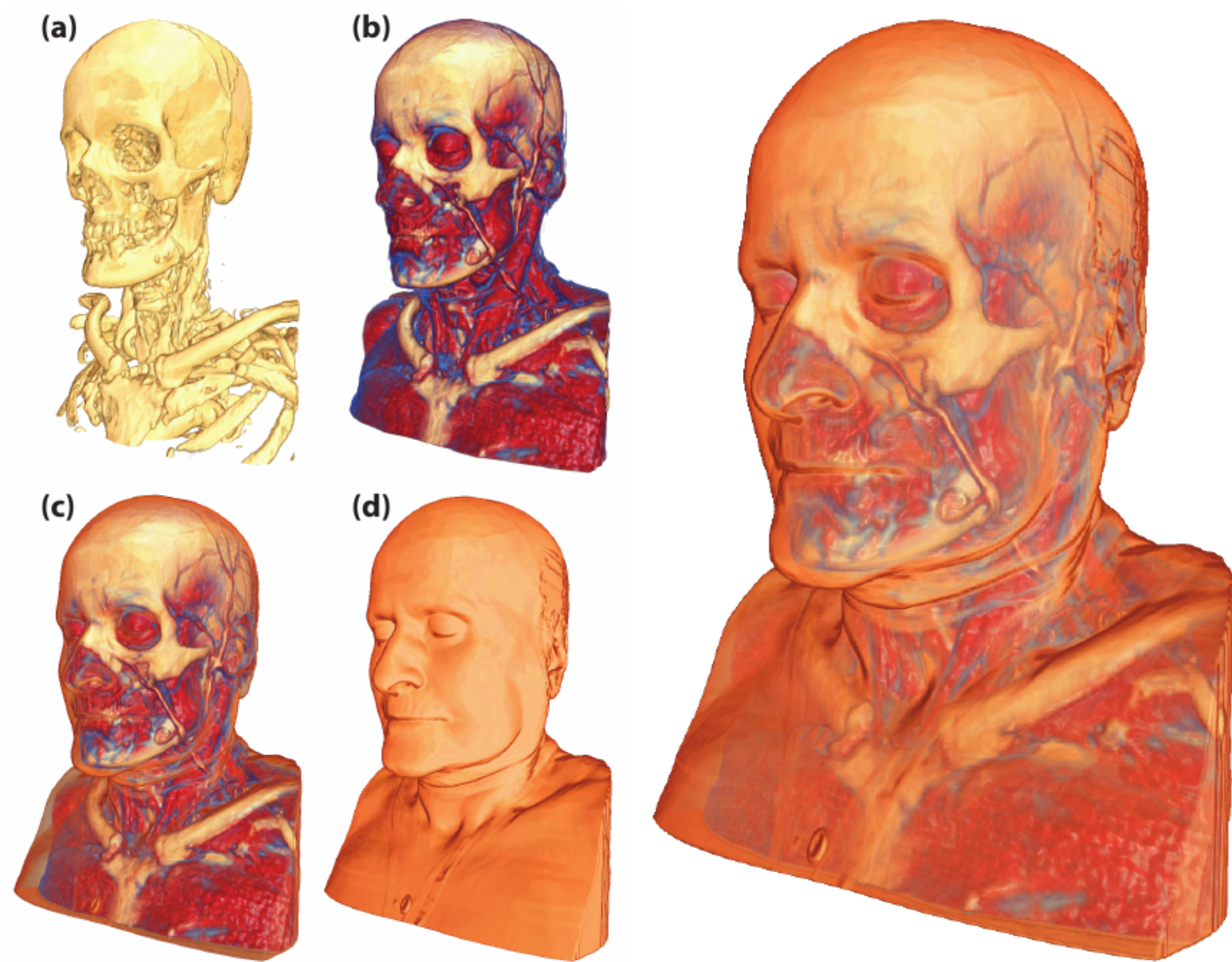

[Bruckner 2007]

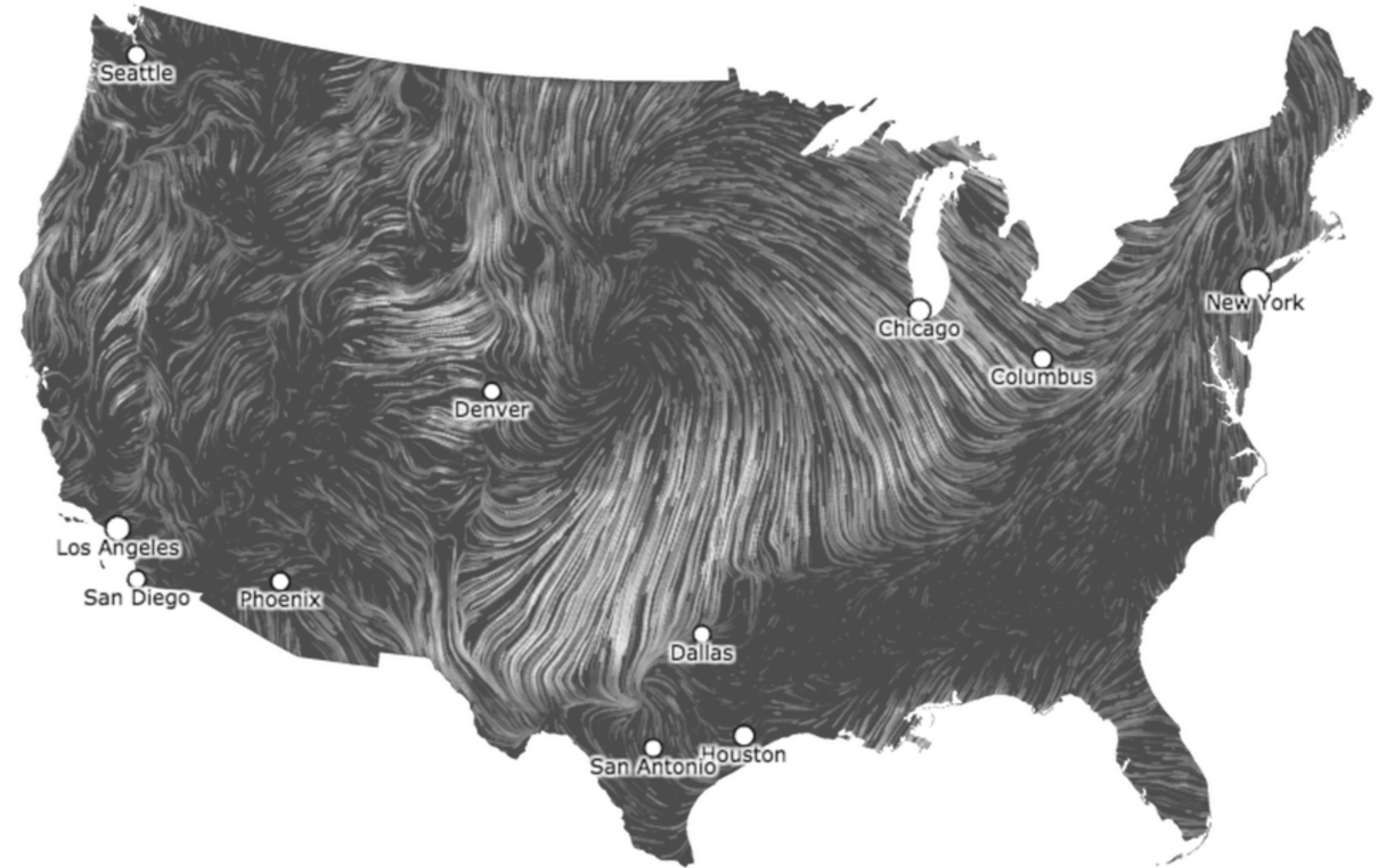

More in Part IV - Spatial Data

Geometry

Shape of items

Explicit spatial positions

Points, lines, curves, surfaces, regions, volumes

Important in Computer Graphics, CAD, ...

Not a core Vis topic

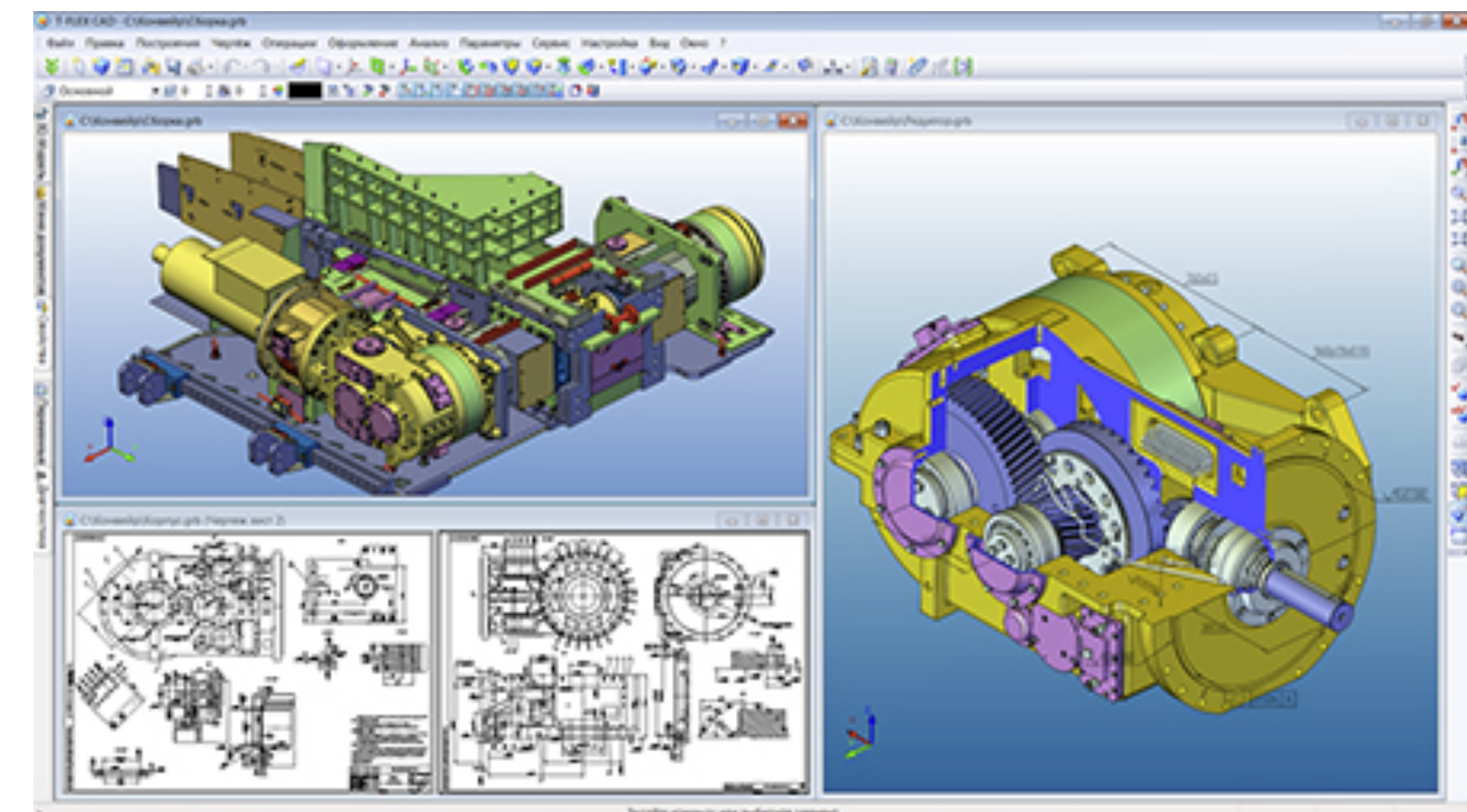
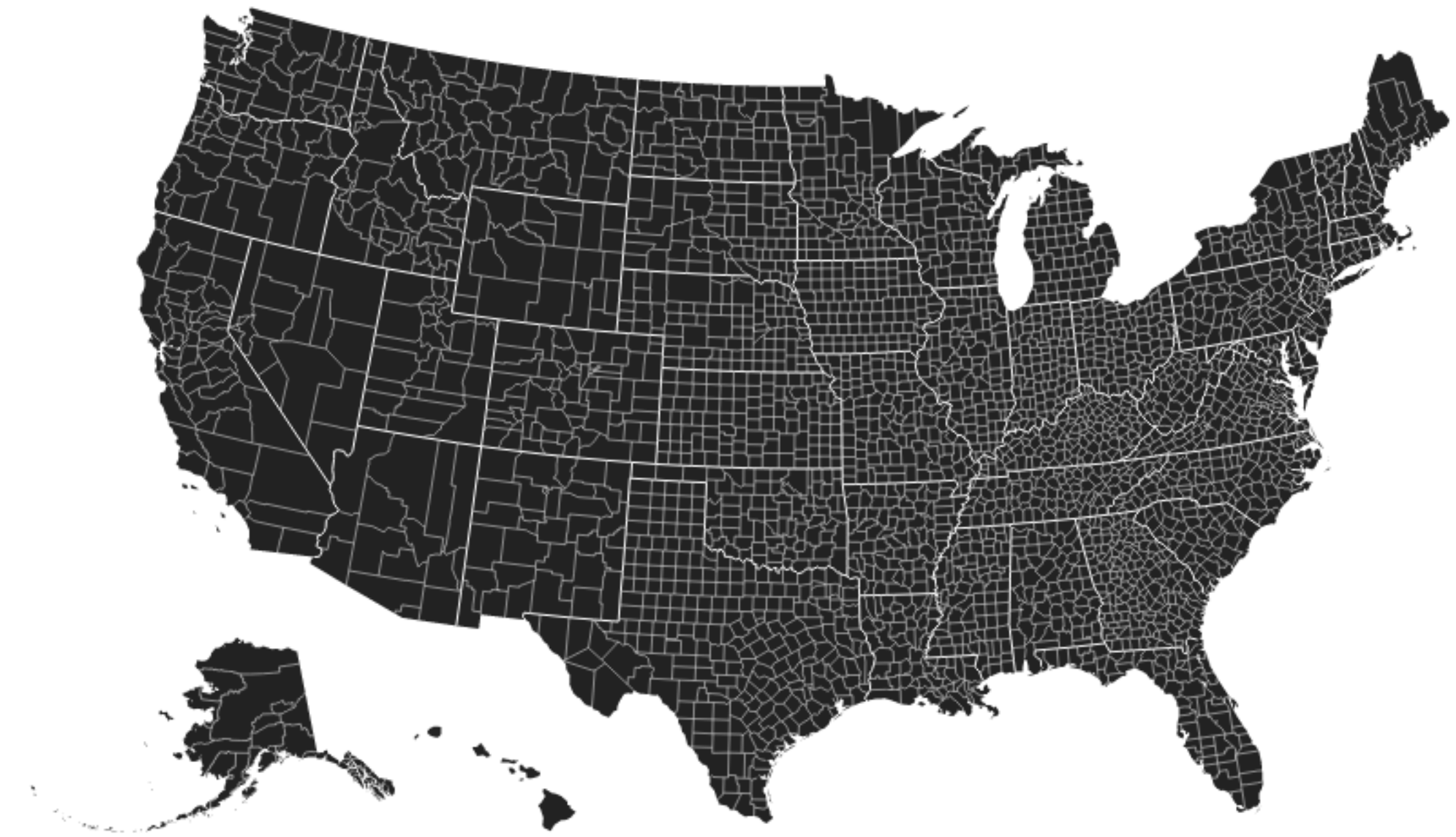

Side Note: Academic Trenches

Information Vis

“Abstract Data”

Tables, Graphs

Free to choose
spatial layout

Visual Analytics

InfoVis + Stats +
Machine learning

Applied Work

Funding buzzword

Scientific Vis

“Spatial
Data” (Fields)

Not free to choose
spatial layout

Find best way to
depict reality

InfoVis or SciVis?

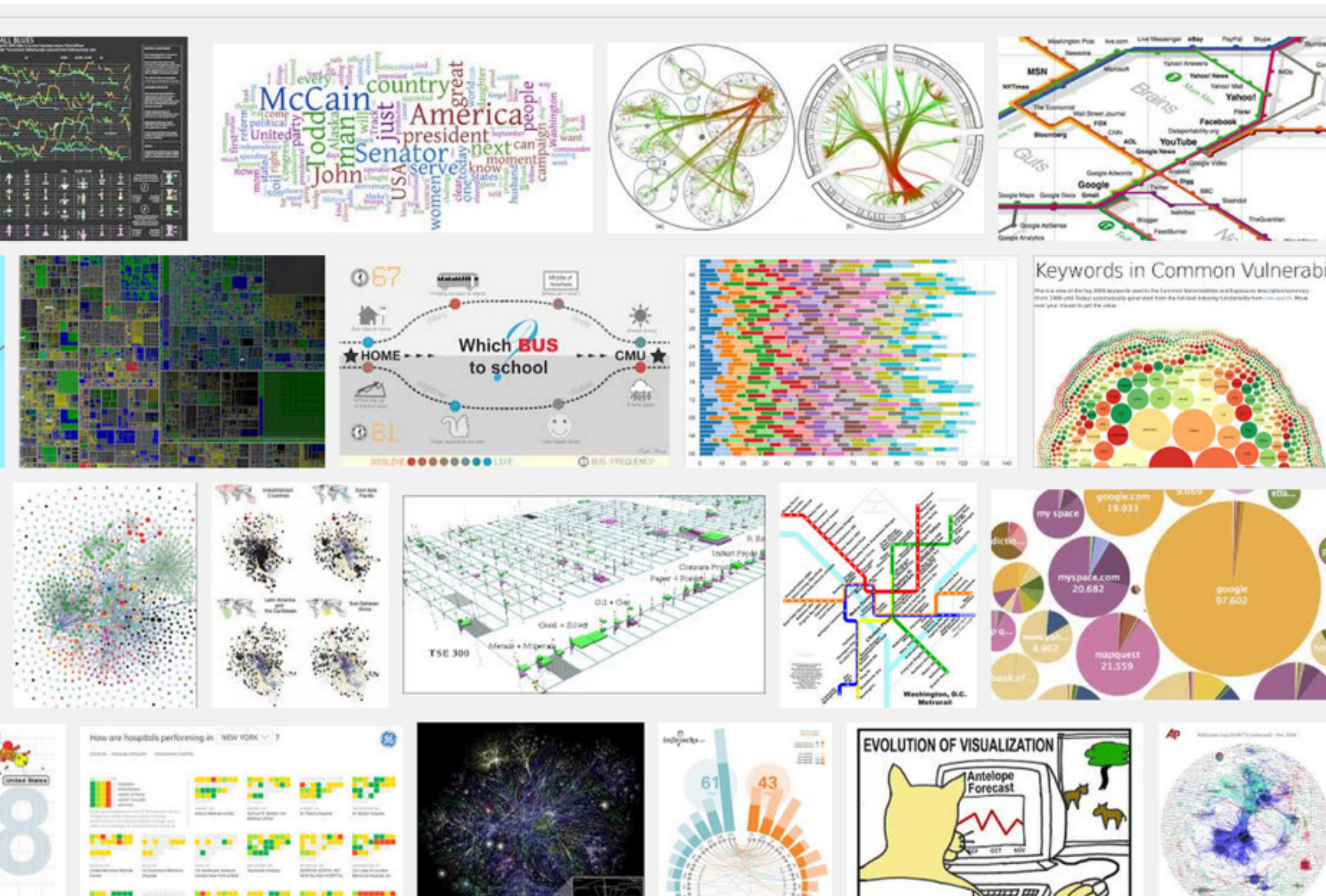

InfoVis: White Background

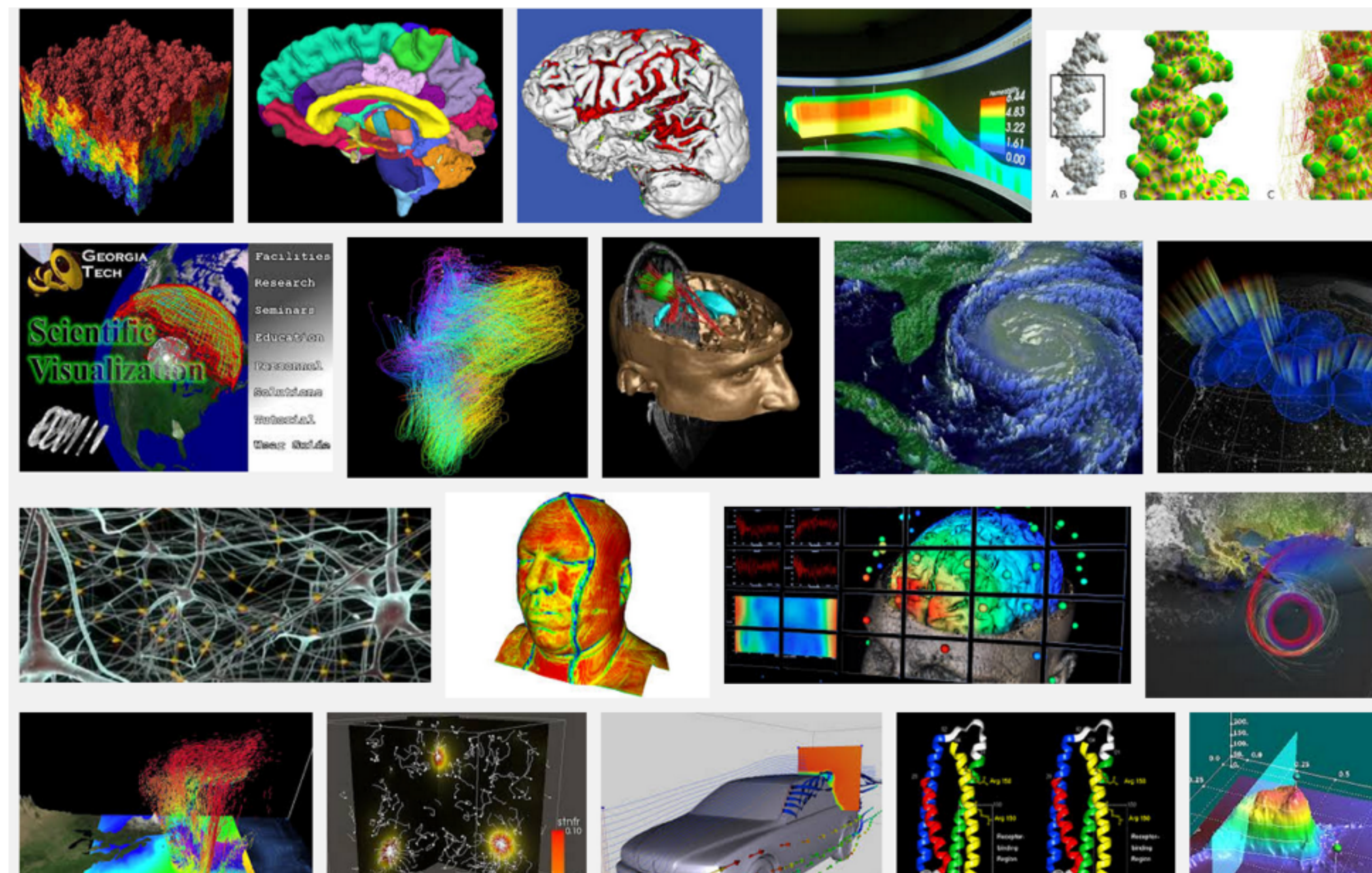

SciVis: Black Background

Other Collections

Sets

Unique items, unordered

Lists

Ordered, duplicates allowed

Clusters

Groups of similar items

Rank	School Name	Academic repu	E	Facult	Citatio	I	I
	Filter: <None>						
1.	Massachusetts Inst						
2.	University of Camb						
3.	Harvard University	100 (1)			100 (1)		
4.	UCL (University Co						
5.	University of Oxfor						
6.	Imperial College L						
7.	Yale University						
8.	University of Chic						

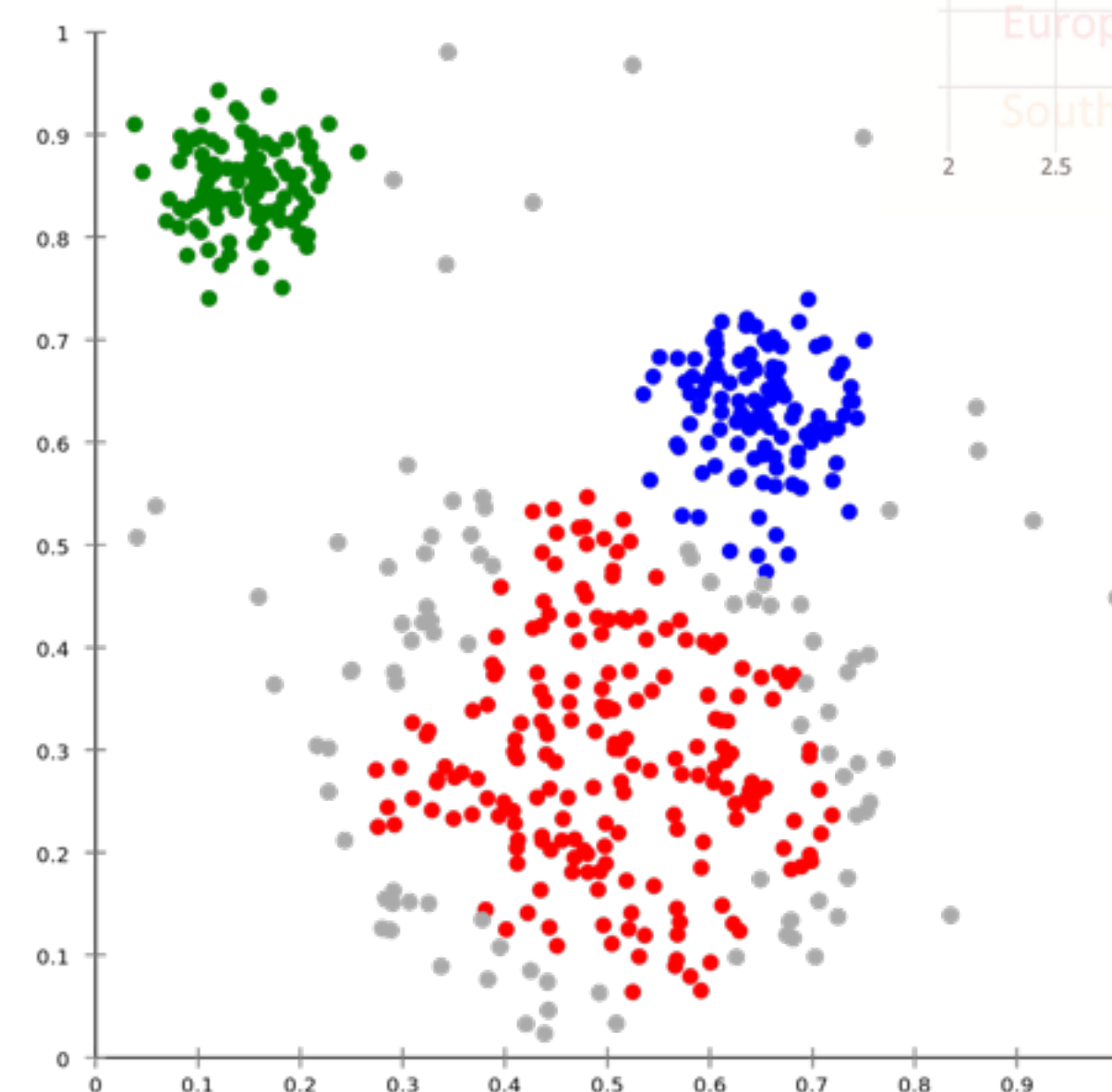
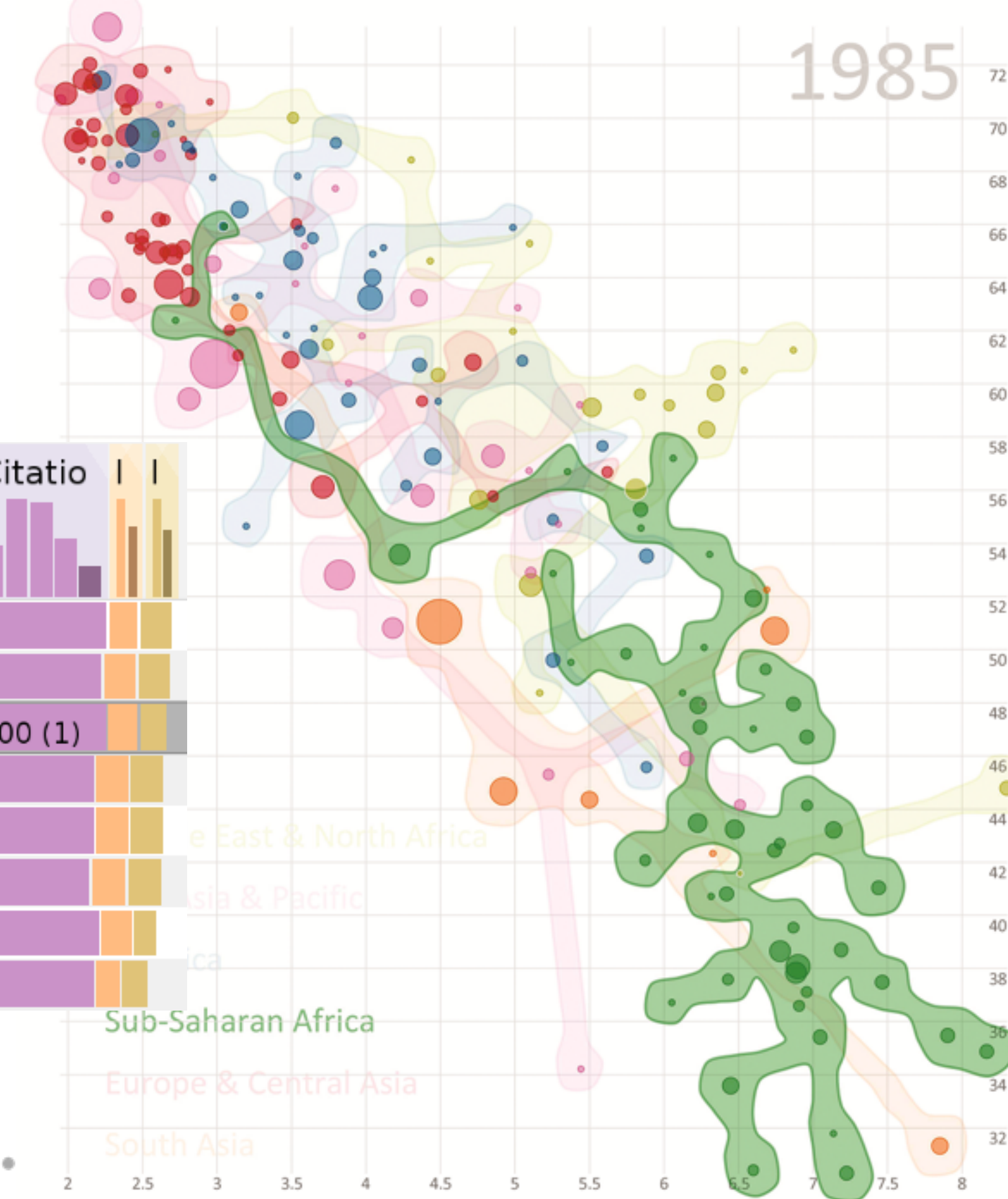

Attribute Types

Which classes of values & measurements are there?

Categorical (nominal)

Compare equality

Fruit, Gender, Movie Genres, File Types

Ordered

Ordinal

Great/Less than defined

Shirt size, Rankings

Quantitative

Arithmetic possible

Length, Weight, Count

→ Categorical



→ Ordered

→ Ordinal



→ Quantitative

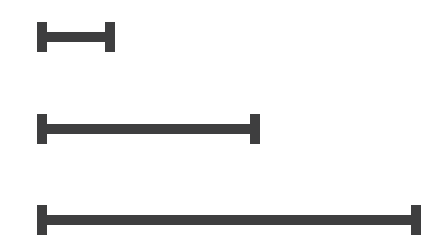

Quantitative Data Type: Interval

There are equal differences between successive points on the scale but the position of zero is arbitrary.

Does Zero mean none?

Dates: Jan 19; Location: (Lat, Long)

Cannot compare directly. Temp in C & F

Only differences (i.e., intervals) can be compared

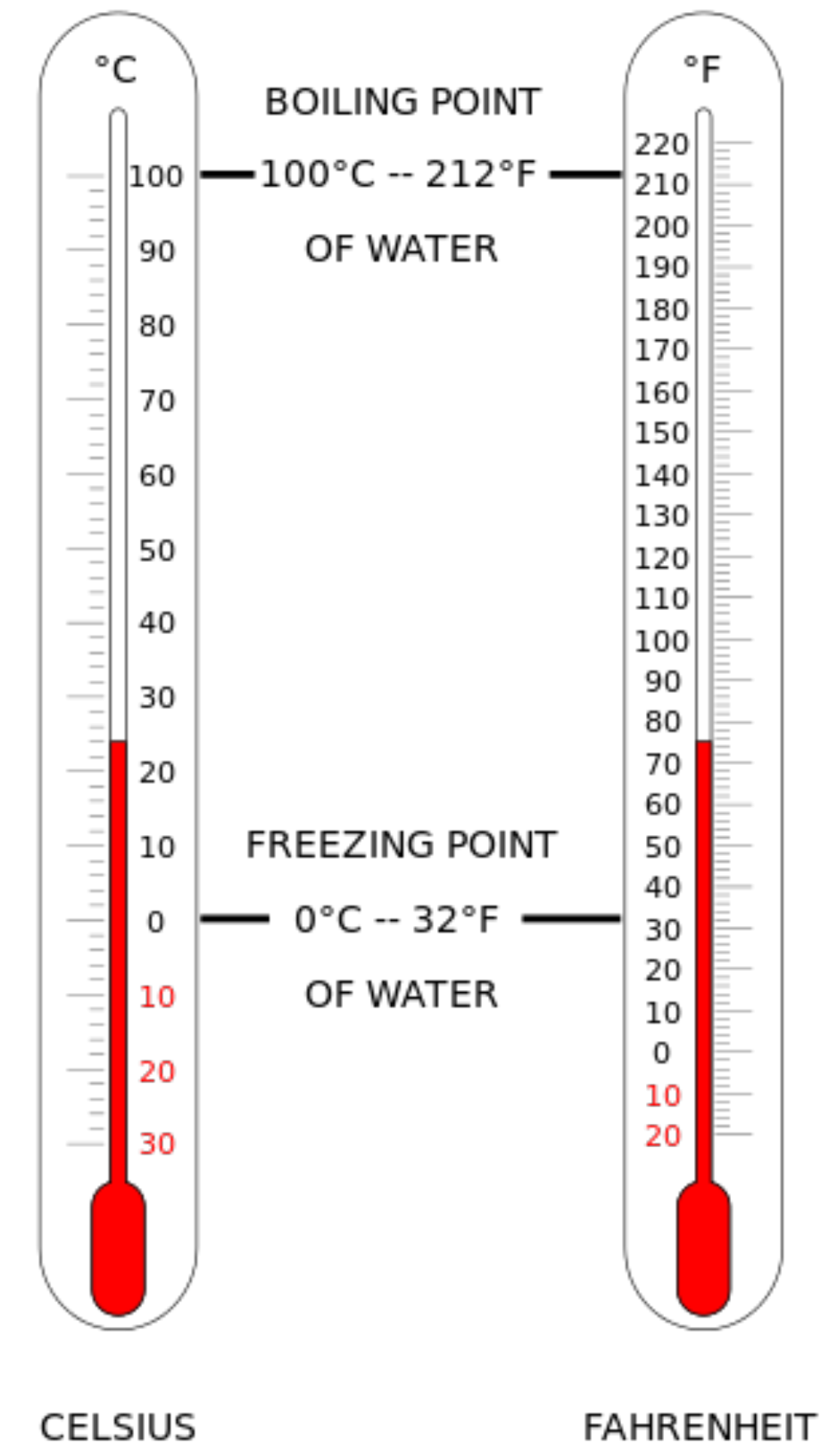

Quantitative Data Types: Ratio

The relative magnitudes of scores and the differences between them matter. The position of zero is fixed.

Zero: there is nothing of the measured entity observed

Measurements: Length, Mass, Age, Weight

Can measure ratios & proportions

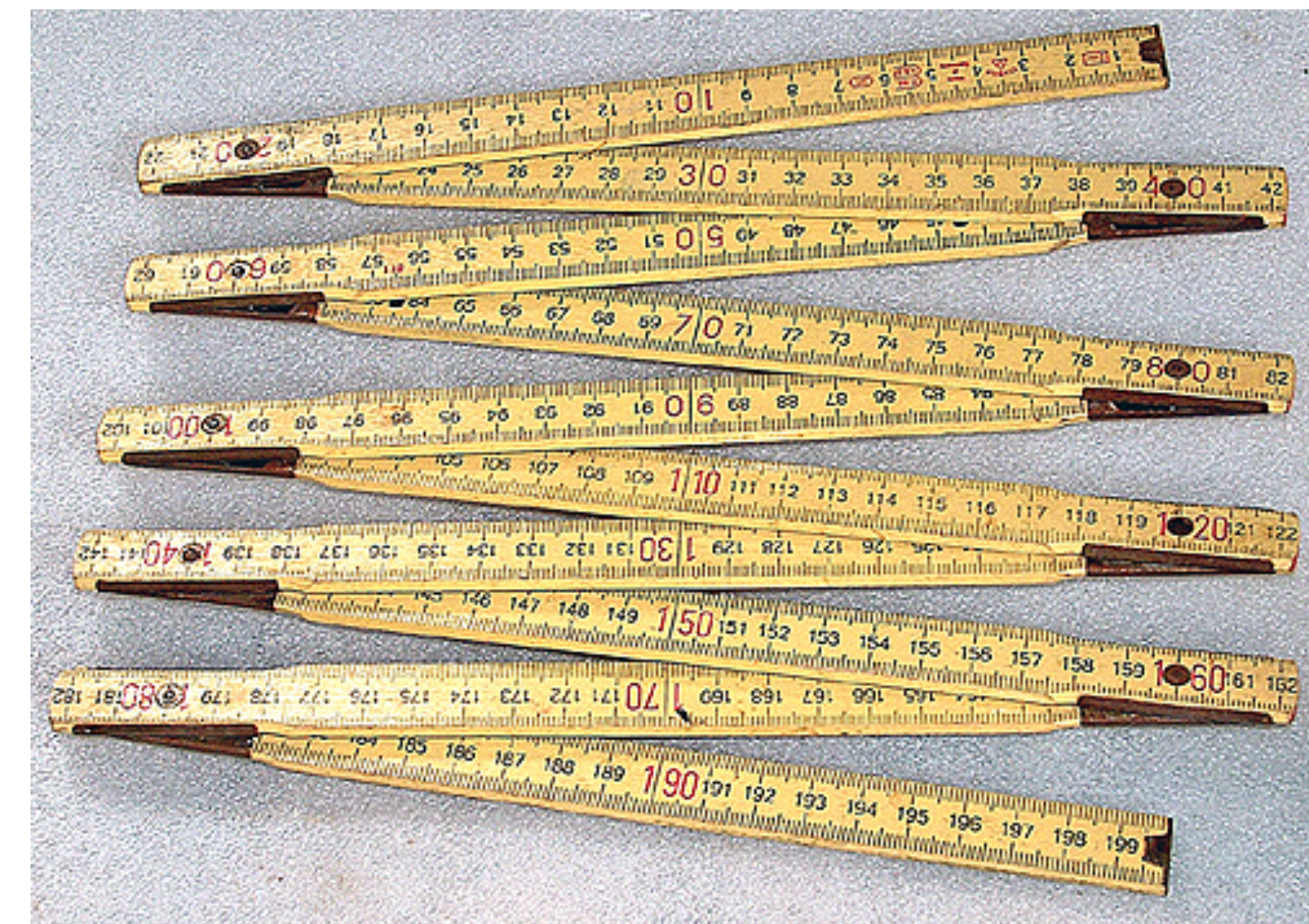

SCIENCE

Vol. 103, No. 2684

Friday, June 7, 1946

On the Theory of Scales of Measurement

S. S. Stevens

Director, Psycho-Acoustic Laboratory, Harvard University

FOR SEVEN YEARS A COMMITTEE of the British Association for the Advancement of Science debated the problem of measurement. Appointed in 1932 to represent Section A (Mathematical and Physical Sciences) and Section J (Psychology), the committee was instructed to consider and report upon the possibility of "quantitative estimates of sensory events"—meaning simply: Is it possible to measure human sensation? Deliberation led only to disagreement, mainly about what is meant by the term measurement. An interim report in 1938 found one member complaining that his colleagues

by the formal (mathematical) properties of the scales. Furthermore—and this is of great concern to several of the sciences—the statistical manipulations that can legitimately be applied to empirical data depend upon the type of scale against which the data are ordered.

A CLASSIFICATION OF SCALES OF MEASUREMENT

Paraphrasing N. R. Campbell (Final Report, p. 340), we may say that measurement, in the broadest sense, is defined as the assignment of numerals to objects or events according to rules. The fact that numerals can be assigned under different rules leads

Scale	Basic Empirical Operations	Mathematical Group Structure	Permissible Statistics (invariantive)
NOMINAL	Determination of equality	<i>Permutation group</i> $x' = f(x)$ $f(x)$ means any one-to-one substitution	Number of cases Mode Contingency correlation
ORDINAL	Determination of greater or less	<i>Isotonic group</i> $x' = f(x)$ $f(x)$ means any monotonic increasing function	Median Percentiles
INTERVAL	Determination of equality of intervals or differences	<i>General linear group</i> $x' = ax + b$	Mean Standard deviation Rank-order correlation Product-moment correlation
RATIO	Determination of equality of ratios	<i>Similarity group</i> $x' = ax$	Coefficient of variation

Data Types

Nominal (categories, labels)

Operations: =, \neq

Ordinal (ordered)

Operations: =, \neq , $>$, $<$

Interval (location of zero arbitrary)

Operations: =, \neq , $>$, $<$, +, - (distance)

Ratio (zero fixed)

Operations: =, \neq , $>$, $<$, +, -, \times , \div (proportions)

Quiz!

What type of variable (Nominal, Ordinal, Interval, or Ratio) are the following:

1. 50 meter race times
2. College major
3. Amazon rating for a product
4. IQ Score
5. Product Name

Sequential & Diverging Data

Sequential:

homogeneous from min to max

people in countries

Diverging:

two or multiple sequences that meet

Elevation dataset: above sea level
& below sea level

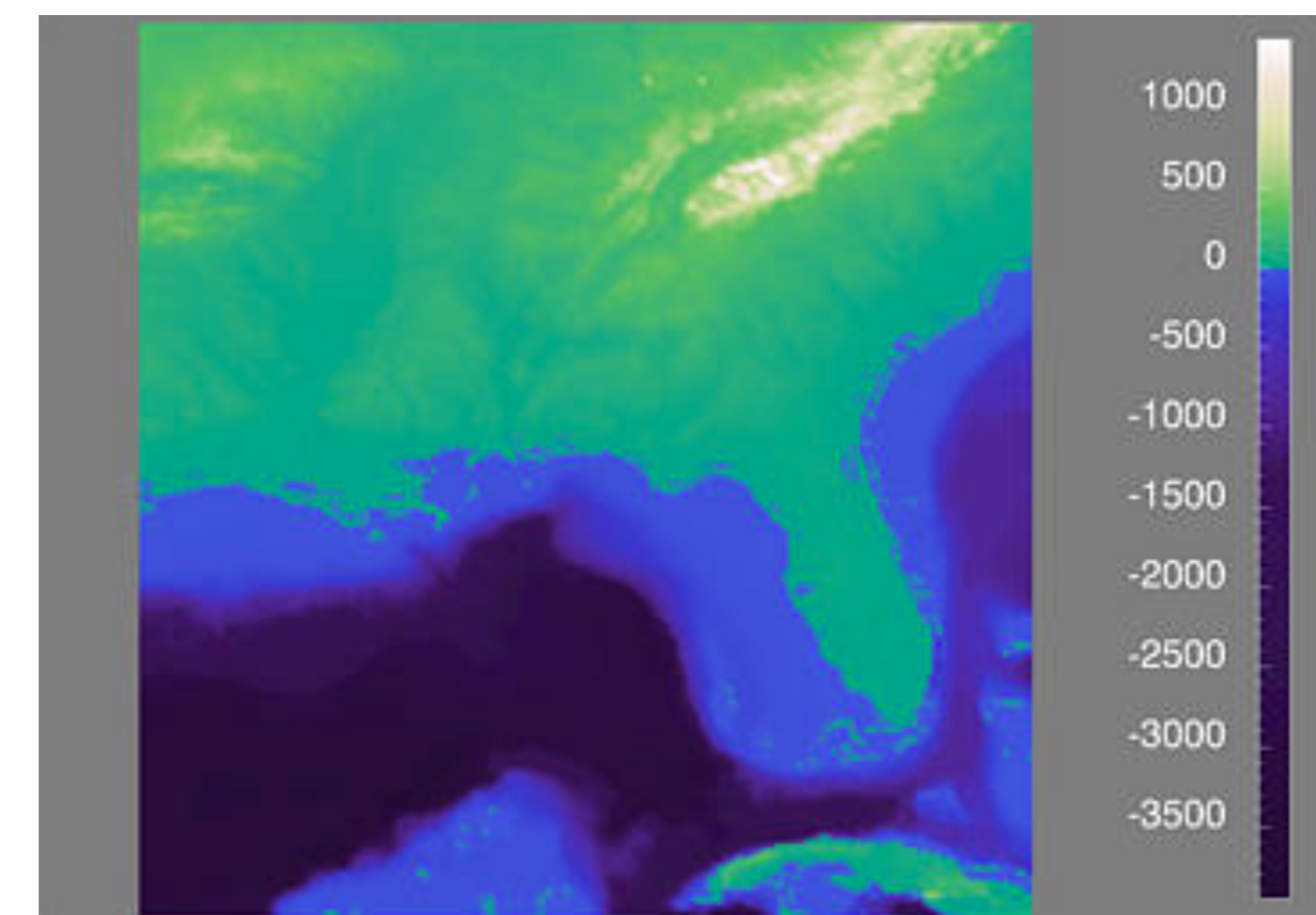
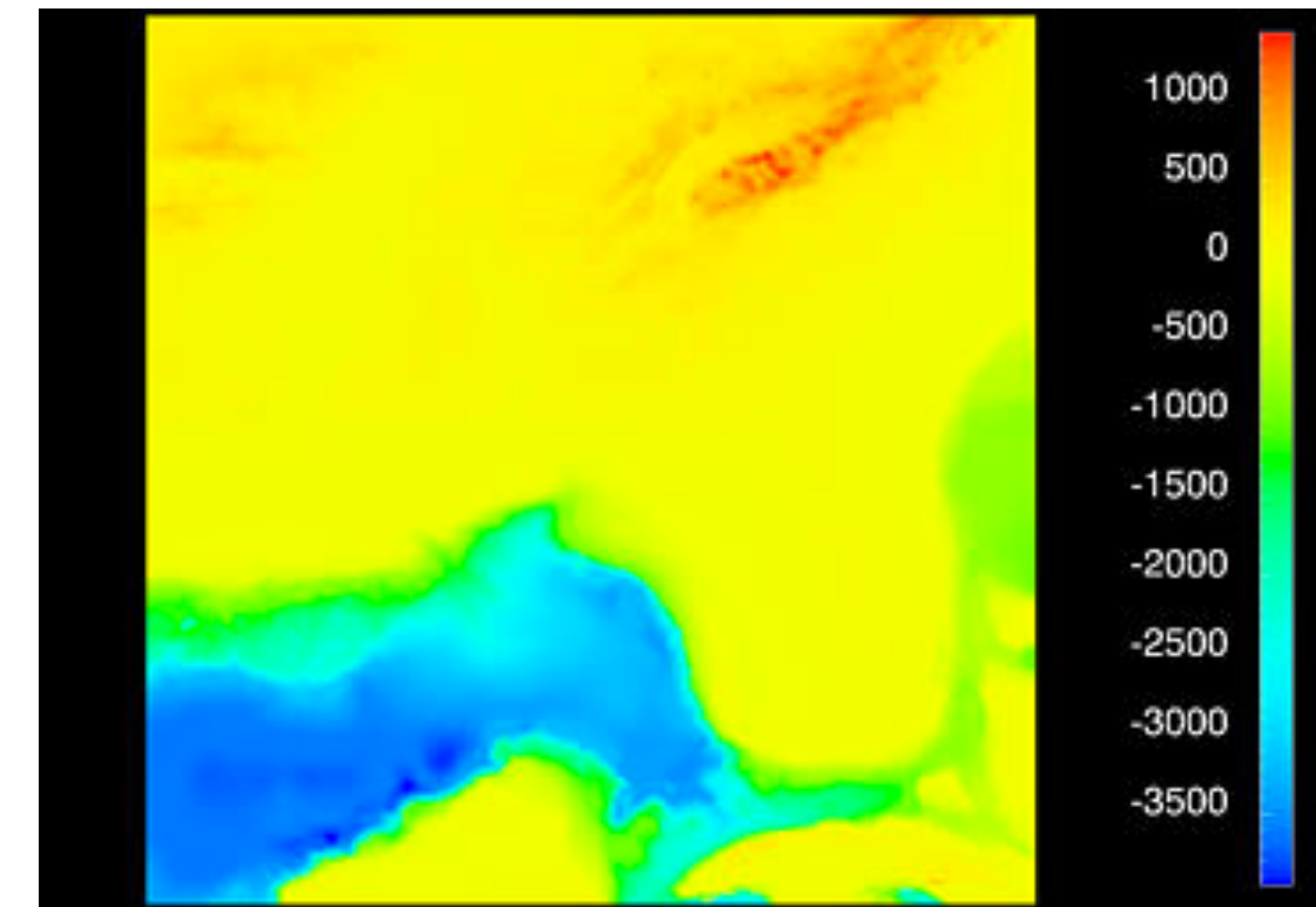

Other Structure

Cyclic data

time (hours, week, month, year)

Aggregation

might be patterns on multiple levels

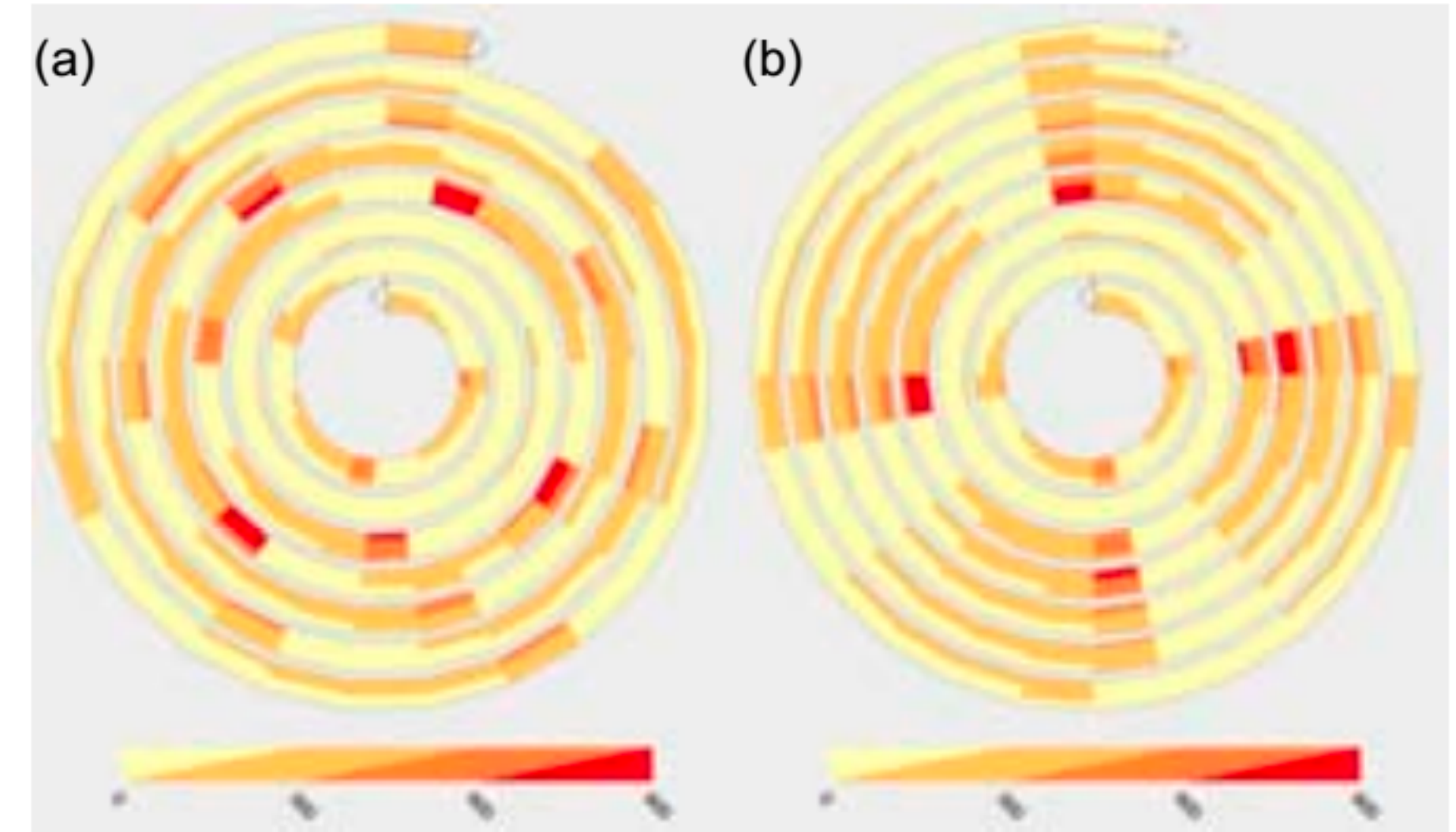

Respiratory disease cases.
Left: 25 day pattern
Right: 28 day pattern
[Tominski 2008]

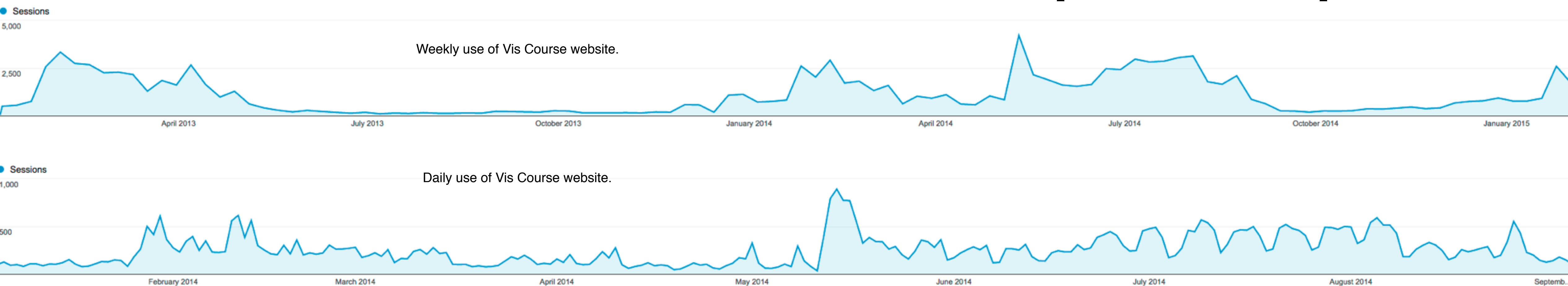

	A	B	C	S	T	U
1	Order ID	Order Date	Order Priority	Product Container	Product Base Margin	Ship Date
2	3	10/14/06	5-Low	Large Box	0.8	10/21/06
3	6	2/21/08	4-Not Specified	Small Pack	0.55	2/22/08
4	32	7/16/07	2-High	Small Pack	0.79	7/17/07
5	32	7/16/07	2-High	Jumbo Box	0.72	7/17/07
6	32	7/16/07	2-High	Medium Box	0.6	7/18/07
7	32	7/16/07	2-High	Medium Box	0.65	7/18/07
8	35	10/23/07	4-Not Specified	Wrap Bag		10/24/07
9	35	10/23/07	4-Not Specified	Small Box		10/25/07
10	36	11/3/07	1-Urgent	Small Box		11/3/07
11	65	3/18/07	1-Urgent	Small Pack		3/19/07
12	66	1/20/05	5-Low	Wrap Bag		1/20/05
13	69	6/4/05	4-Not Specified	Small Pack		6/6/05
14	69	6/4/05	4-Not Specified	Wrap Bag		6/6/05
15	70	12/18/06	5-Low	Small Box		12/23/06
16	70	12/18/06	5-Low	Wrap Bag		12/23/06
17	96	4/17/05	2-High	Small Box	0.55	4/19/05
18	97	1/29/06	3-Medium	Small Box	0.38	1/30/06
19	129	11/19/08	5-Low	Small Box	0.37	11/28/08
20	130	5/8/08	2-High	Small Box	0.37	5/9/08
21	130	5/8/08	2-High	Medium Box	0.38	5/10/08
22	130	5/8/08	2-High	Small Box	0.6	5/11/08
23	132	6/11/06	3-Medium	Medium Box	0.6	6/12/06
24	132	6/11/06	3-Medium	Jumbo Box	0.69	6/14/06
25	134	5/1/08	4-Not Specified	Large Box	0.82	5/3/08
26	135	10/21/07	4-Not Specified	Small Pack	0.64	10/23/07
27	166	9/12/07	2-High	Small Box	0.55	9/14/07
28	193	8/8/06	1-Urgent	Medium Box	0.57	8/10/06
29	194	4/5/08	3-Medium	Wrap Bag	0.42	4/7/08

**Item/Element/
(Independent)
Variable**

	A	B	C	S	T	U
1	Order ID	Order Date	Order Priority	Product Container	Product Base Margin	Ship Date
2	3	10/14/06	5-Low	Large Box	0.8	10/21/06
3	6	2/21/08	4-Not Specified	Small Pack		2/22/08
4	32	7/16/07	2-High	Small Pack		7/17/07
5	32	7/16/07	2-High	Jumbo Box		7/17/07
6	32	7/16/07	2-High	Medium Box		7/18/07
7	32	7/16/07	2-High	Medium Box		7/18/07
8	35	10/23/07	4-Not Specified	Wrap Bag		10/24/07
9	35	10/23/07	4-Not Specified	Small Box		10/25/07
10	36	11/3/07	1-Urgent	Small Box		11/3/07
11	65	3/18/07	1-Urgent	Small Pack		3/19/07
12	66	1/20/05	5-Low	Wrap Bag		1/20/05
13	69	6/4/05	4-Not Specified	Small Pack	0.44	6/6/05
14	69	6/4/05	4-Not Specified	Wrap Bag	0.6	6/6/05
15	70	12/18/06	5-Low	Small Box	0.59	12/23/06
16	70	12/18/06	5-Low	Wrap Bag	0.82	12/23/06
17	96	4/17/05	2-High	Small Box	0.55	4/19/05
18	97	1/29/06	3-Medium	Small Box	0.38	1/30/06
19	129	11/19/08	5-Low	Small Box	0.37	11/28/08
20	130	5/8/08	2-High	Small Box	0.37	5/9/08
21	130	5/8/08	2-High	Medium Box	0.38	5/10/08
22	130	5/8/08	2-High	Small Box	0.6	5/11/08
23	132	6/11/06	3-Medium	Medium Box	0.6	6/12/06
24	132	6/11/06	3-Medium	Jumbo Box	0.69	6/14/06
25	134	5/1/08	4-Not Specified	Large Box	0.82	5/3/08
26	135	10/21/07	4-Not Specified	Small Pack	0.64	10/23/07
27	166	9/12/07	2-High	Small Box	0.55	9/14/07
28	193	8/8/06	1-Urgent	Medium Box	0.57	8/10/06
29	194	4/5/08	3-Medium	Wrap Bag	0.42	4/7/08

**Attribute/
Dimension/
(Dependent)
Variable/
Feature**

	A	B	C	S	T	U
1	Order ID	Order Date	Order Priority	Product Container	Product Base Margin	Ship Date
2	3	10/14/06	5-Low	Large Box	0.9	10/21/06
3	6	2/21/08	4-Not Specified	Small Pack	0.5	2/22/08
4	32	7/16/07	2-High	Small Pack	0.9	7/17/07
5	32	7/16/07	2-High	Jumbo Box	0.72	7/17/07
6	32	7/16/07	2-High	Medium Box	0.6	7/18/07
7	32	7/16/07	2-High	Medium Box	0.65	7/18/07
8	35	10/23/07	4-Not Specified	Wrap Bag	0.52	10/24/07
9	35	10/23/07	4-Not Specified	Small Box	0.58	10/25/07
10	36	11/3/07	1-Urgent	Small Box	0.55	11/3/07
11	65	3/18/07	1-Urgent	Small Pack	0.49	3/19/07
12	66	1/20/05	5-Low	Wrap Bag	0.56	1/20/05
13	69	6/4/05	4-Not Specified	Small Pack	0.44	6/6/05
14	69	6/4/05	4-Not Specified	Wrap Bag	0.6	6/6/05
15	70	12/18/06	5-Low	Small Box	0.59	12/23/06
16	70	12/18/06	5-Low	Wrap Bag	0.82	12/23/06
17	96	4/17/05	2-High	Small Box	0.55	4/19/05
18	97	1/29/06	3-Medium	Small Box	0.38	1/30/06
19	129	11/19/08	5-Low	Small Box	0.37	11/28/08
20	130	5/8/08	2-High	Small Box	0.37	5/9/08
21	130	5/8/08	2-High	Medium Box	0.38	5/10/08
22	130	5/8/08	2-High	Small Box	0.6	5/11/08
23	132	6/11/06	3-Medium	Medium Box	0.6	6/12/06
24	132	6/11/06	3-Medium	Jumbo Box	0.69	6/14/06
25	134	5/1/08	4-Not Specified	Large Box	0.82	5/3/08
26	135	10/21/07	4-Not Specified	Small Pack	0.64	10/23/07
27	166	9/12/07	2-High	Small Box	0.55	9/14/07
28	193	8/8/06	1-Urgent	Medium Box	0.57	8/10/06
29	194	4/5/08	3-Medium	Wrap Bag	0.42	4/7/08

Semantics

	A	B	C	S	T	U
1	Order ID	Order Date	Order Priority	Product Container	Product Base Margin	Ship Date
2	3	10/14/06	5-Low	Large Box	0.8	10/21/06
3	6	2/21/08	4-Not Specified	Small Pack	0.55	2/22/08
4	32	7/16/07	2-High	Small Pack	0.79	7/17/07
5	32	7/16/07	2-High	Jumbo Box	0.72	7/17/07
6	32	7/16/07	2-High	Medium Box	0.6	7/18/07
7	32	7/16/07	2-High	Medium Box		7/18/07
8	35	10/23/07	4-Not Specified	Wrap Bag		10/24/07
9	35	10/23/07	4-Not Specified	Small Box	0.58	10/25/07
10	36	11/3/07	1-Urgent	Small Box	0.55	11/3/07
11	65	3/18/07	1-Urgent	Small Pack	0.49	3/19/07
12	66	1/20/05	5-Low	Wrap Bag	0.56	1/20/05
13	69	6/4/05	4-Not Specified	Small Pack	0.44	6/6/05
14	69	6/4/05	4-Not Specified	Wrap Bag	0.6	6/6/05
15	70	12/18/06	5-Low	Small Box	0.59	12/23/06
16	70	12/18/06	5-Low	Wrap Bag	0.82	12/23/06
17	96	4/17/05	2-High	Small Box	0.55	4/19/05
18	97	1/29/06	3-Medium	Small Box	0.38	1/30/06
19	129	11/19/08	5-Low	Small Box	0.37	11/28/08
20	130	5/8/08	2-High	Small Box	0.37	5/9/08
21	130	5/8/08	2-High	Medium Box	0.38	5/10/08
22	130	5/8/08	2-High	Small Box	0.6	5/11/08
23	132	6/11/06	3-Medium	Medium Box	0.6	6/12/06
24	132	6/11/06	3-Medium	Jumbo Box	0.69	6/14/06
25	134	5/1/08	4-Not Specified	Large Box	0.82	5/3/08
26	135	10/21/07	4-Not Specified	Small Pack	0.64	10/23/07
27	166	9/12/07	2-High	Small Box	0.55	9/14/07
28	193	8/8/06	1-Urgent	Medium Box	0.57	8/10/06
29	194	4/5/08	3-Medium	Wrap Bag	0.42	4/7/08

Keys?

	A	B	C	S	T	U
1	Order ID	Order Date	Order Priority	Product Container	Product Base Margin	Ship Date
2	3	10/14/06	5-Low	Large Box	0.8	10/21/06
3	6	2/21/08	4-Not Specified	Small Pack	0.55	2/22/08
4	32	7/16/07	2-High	Small Pack	0.79	7/17/07
5	32	7/16/07	2-High	Jumbo Box	0.72	7/17/07
6	32	7/16/07	2-High	Medium Box	0.6	7/18/07
7	32	7/16/07	2-High	Medium Box	0.65	7/18/07
8	35	10/23/07	4-Not Specified	Wrap Bag	0.52	10/24/07
9	35	10/23/07	4-Not Specified	Small Box	0.58	10/25/07
10	36	11/3/07	1-Urgent	Small Box	0.55	11/3/07
11	65	3/18/07	1-Urgent	Small Pack	0.49	3/19/07
12	66	1/20/05	5-Low	Wrap Bag	0.56	1/20/05
13	69	6/4/05	4-Not Specified	Small Pack	0.44	6/6/05
14	69	6/4/05	4-Not Specified	Wrap Bag	0.6	6/6/05
15	70	12/18/06	5-Low	Small Box	0.59	12/23/06
16	70	12/18/06	5-Low	Wrap Bag	0.82	12/23/06
17	96	4/17/05	2-High	Small Box	0.55	4/19/05
18	97	1/29/06	3-Medium	Small Box	0.38	1/30/06
19	129	11/19/08	5-Low	Small Box	0.37	11/28/08
20	130	5/8/08	2-High	Small Box	0.37	5/9/08
21	130	5/8/08	2-High	Medium Box	0.38	5/10/08
22	130	5/8/08	2-High	Small Box		5/11/08
23	132	6/11/06	3-Medium	Medium Box		6/12/06
24	132	6/11/06	3-Medium	Jumbo Box		6/14/06
25	134	5/1/08	4-Not Specified	Large Box		5/3/08
26	135	10/21/07	4-Not Specified	Small Pack	0.57	10/23/07
27	166	9/12/07	2-High	Small Box	0.55	9/14/07
28	193	8/8/06	1-Urgent	Medium Box	0.57	8/10/06
29	194	4/5/08	3-Medium	Wrap Bag	0.42	4/7/08

Attribute
Types?

◇	A	B	C	S	T	U
1	Order ID	Order Date	Order Priority	Product Container	Product Base Margin	Ship Date
2	3	10/14/06	5-Low	Large Box	0.8	10/21/06
3	6	2/21/08	4-Not Specified	Small Pack	0.55	2/22/08
4	32	7/16/07	2-High	Small Pack	0.79	7/17/07
5	32	7/16/07	2-High	Jumbo Box	0.72	7/17/07
6	32	7/16/07	2-High	Medium Box	0.6	7/18/07
7	32	7/16/07	2-High	Medium Box	0.65	7/18/07
8	35	10/23/07	4-Not Specified	Wrap Bag	0.52	10/24/07
9	35	10/23/07	4-Not Specified	Small Box	0.58	10/25/07
10	36	11/3/07	1-Urgent	Small Box	0.55	11/3/07
11	65	3/18/07	1-Urgent	Small Pack	0.49	3/19/07
12	66	1/20/05	5-Low	Wrap Bag	0.56	1/20/05
13	69	6/4/05	4-Not Specified	Small Pack	0.44	6/6/05
14	69	6/4/05	4-Not Specified	Wrap Bag	0.6	6/6/05
15	70	12/18/06	5-Low	Small Box	0.59	12/23/06
16	70	12/18/06	5-Low	Wrap Bag	0.82	12/23/06
17	96	4/17/05	2-High	Small Box	0.55	4/19/05
18	97	1/29/06	3-Medium	Small Box	0.38	1/30/06
19	129	11/19/08	5-Low	Small Box	0.37	11/28/08
20	130	5/8/08	2-High	Small Box	0.37	5/9/08
21	130	5/8/08	2-High	Medium Box	0.38	5/10/08
22	130	5/8/08	2-High	Small Box	0.6	5/11/08
23	132	6/11/06	3-Medium	Medium Box		
24	132	6/11/06	3-Medium	Jumbo Box		
25	134	5/1/08	4-Not Specified	Large Box		
26	135	10/21/07	4-Not Specified	Small Pack		
27	166	9/12/07	2-High	Small Box		
28	193	8/8/06	1-Urgent	Medium Box		
29	194	4/5/08	3-Medium	Wrap Bag		
30	194	4/5/08	3-Medium	Wrap Bag		

Categorical
Ordinal
Quantitative

Data vs. Conceptual Model

Data Model: Low-level description of the data

Set with operations, e.g., floats with +, -, /, *

Conceptual Model: Mental construction

Includes semantics, supports reasoning

Data	Conceptual
1D floats	temperature
3D vector of floats	space

Data vs. Conceptual Model

From data model...

32.5, 54.0, -17.3, ... (floats)

using conceptual model...

Temperature

to data type

Continuous to 4 significant digits (Q)

Hot, warm, cold (O)

Burned vs. Not burned (N)

Combinations, Derived Data

Networks can have attributes

Attributes have hierarchies

Data types can be transformed

Real life is complicated...